



Replacement Windows & Doors



2023

Impress the Weather



Table of Contents

Introduction to Cambridge & Edgemont Windows	2
Edgemont Replacement Windows	3
Cambridge Replacement Windows	5
Style Options	7
Patio Doors	9
Options & Accessories	11-14

Viwinco offers two high-performance replacement product lines to meet your needs.

Whether you're seeking to upgrade the look and value of your home, or increase its energy efficiency, Viwinco products are designed to meet your needs. A majority of the manufacturing processes are done in-house, resulting in short lead times and a heavy focus on quality and customer service you would expect from a family-owned company.

Cambridge

Our premier high-performance replacement window is loaded with top features and customizable options. Cambridge windows also come with a lifetime warranty—which includes glass breakage.

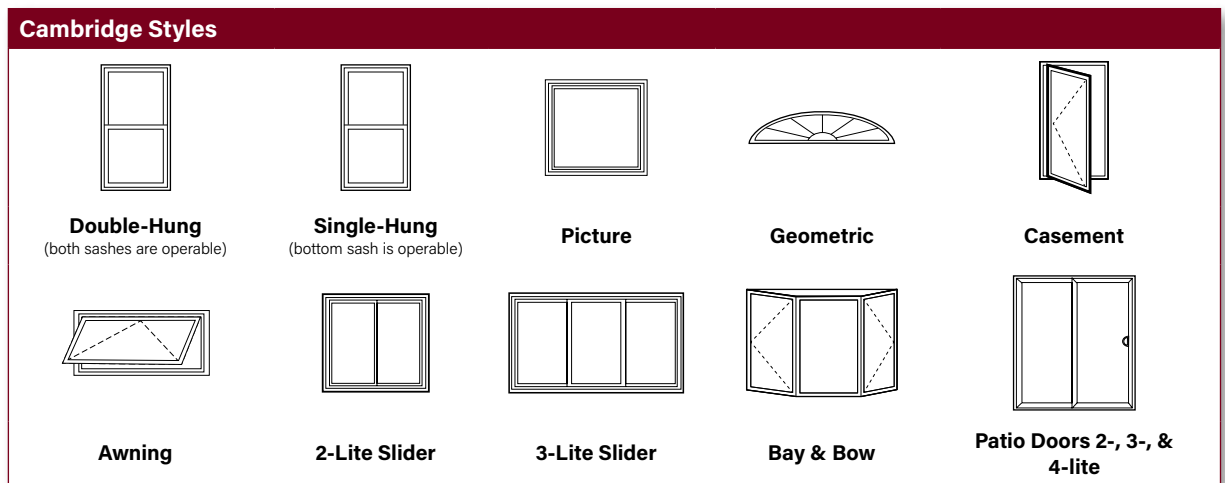

Edgemont

An attractive, clean and simple design defines our Edgemont product line. Edgemont windows provide energy efficiency and affordability to every homeowner.

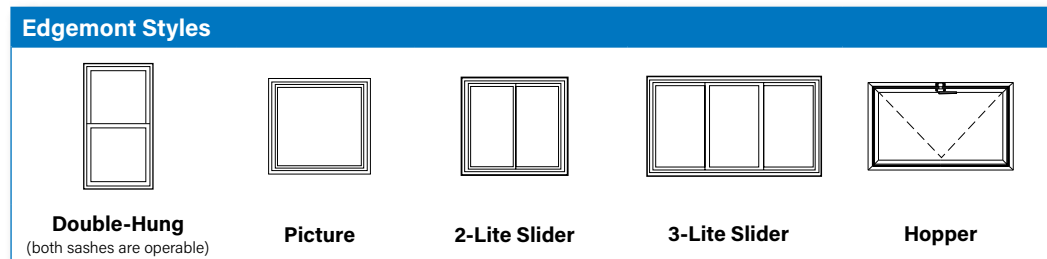

Our Standard High-Performance Insulated Glass Unit (IGU)

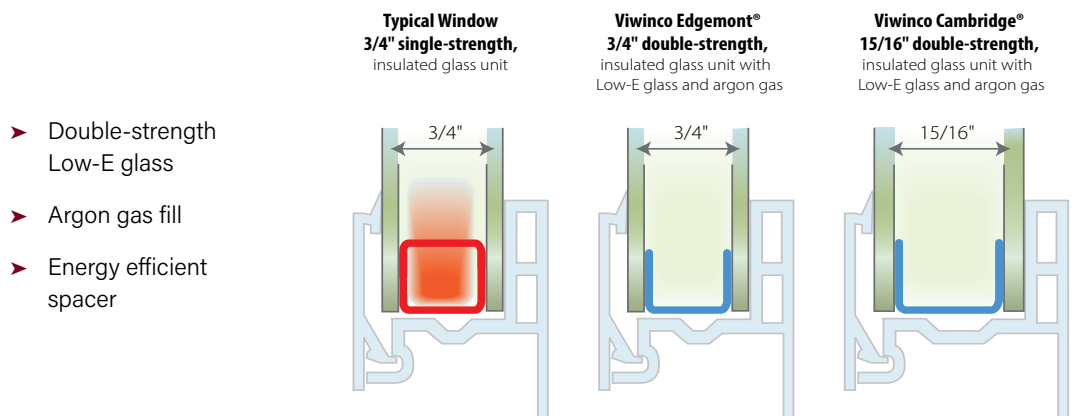

Edgemont[®] Replacement Windows.

Our Edgemont replacement line offers exceptional value at a cost-effective price.



Replacing inefficient windows is one of the most effective ways to add value to your house. Doing so saves you money on energy bills by reducing the drafts and heat loss from older windows. It also increases energy efficiency during the summer by allowing your air conditioner to cool your home faster and more efficiently. Edgemont windows provide the long-lasting durability you deserve at an affordable price.

Edgemont windows are available in white or tan. Other options include grids, and colored glass. See pages 11-14 to learn more about Edgemont customization.



Top: Edgemont replacement double-hungs add a touch of radiance to this homey split-level.

Left: Interior view of an Edgemont picture window flanked by double-hungs. We offer various combination units in our Edgemont line.

Performance You Can Count On

Standard Features

1. Chambered, 100% virgin vinyl profiles add thermal efficiency and structural strength
2. Beveled exterior for traditional styling
3. 3/4" Insulated glass units with Low-E double-strength glass, thermally efficient spacer, and argon gas fill are standard and contribute to excellent thermal performance
4. Cam-style lock with adjustable keeper for reliable alignment and positive locking
5. Sash interlock hooks the bottom and top sash together and to the frame on hung windows, providing increased thermal efficiency by blocking air from entering or escaping
6. 5-Degree true sloped sill directs water and debris away from your home
7. Screen track secures screen in place to better block insects
8. Sill angle accessory pocket simplifies sill angle installation
9. Fully fusion-welded frame and sashes contribute to thermal performance, durability, and low-maintenance.
10. Dual nite vents limit sash travel for increased control over ventilation
11. Low-profile tilt latches provide an uncluttered view
12. Double weatherstripping adds to thermal performance
13. Stainless steel, 1/2" constant-force balance eliminates sash drift and never needs adjusting, allowing for easy window operation time after time
14. 1-1/8" Weatherstripped, replaceable sill dam is mortised into the jamb, providing aesthetic appeal, ease of installation, and protection against drafts and water infiltration
15. Molded-in, curved lift rails on both sashes make sash operation easy and comfortable
16. 3/8" Trimmable leg flanges can be cut down to fit slightly irregular rough openings

Heavy-duty extruded half-screens come standard on Edgemont products. For enhanced performance, we also offer the option of our heavy-duty extruded full screens. See page 14 for details.

Lifetime limited warranty coverage on insulated glass unit and hardware. For more details about our warranty, see www.Viwinco.com

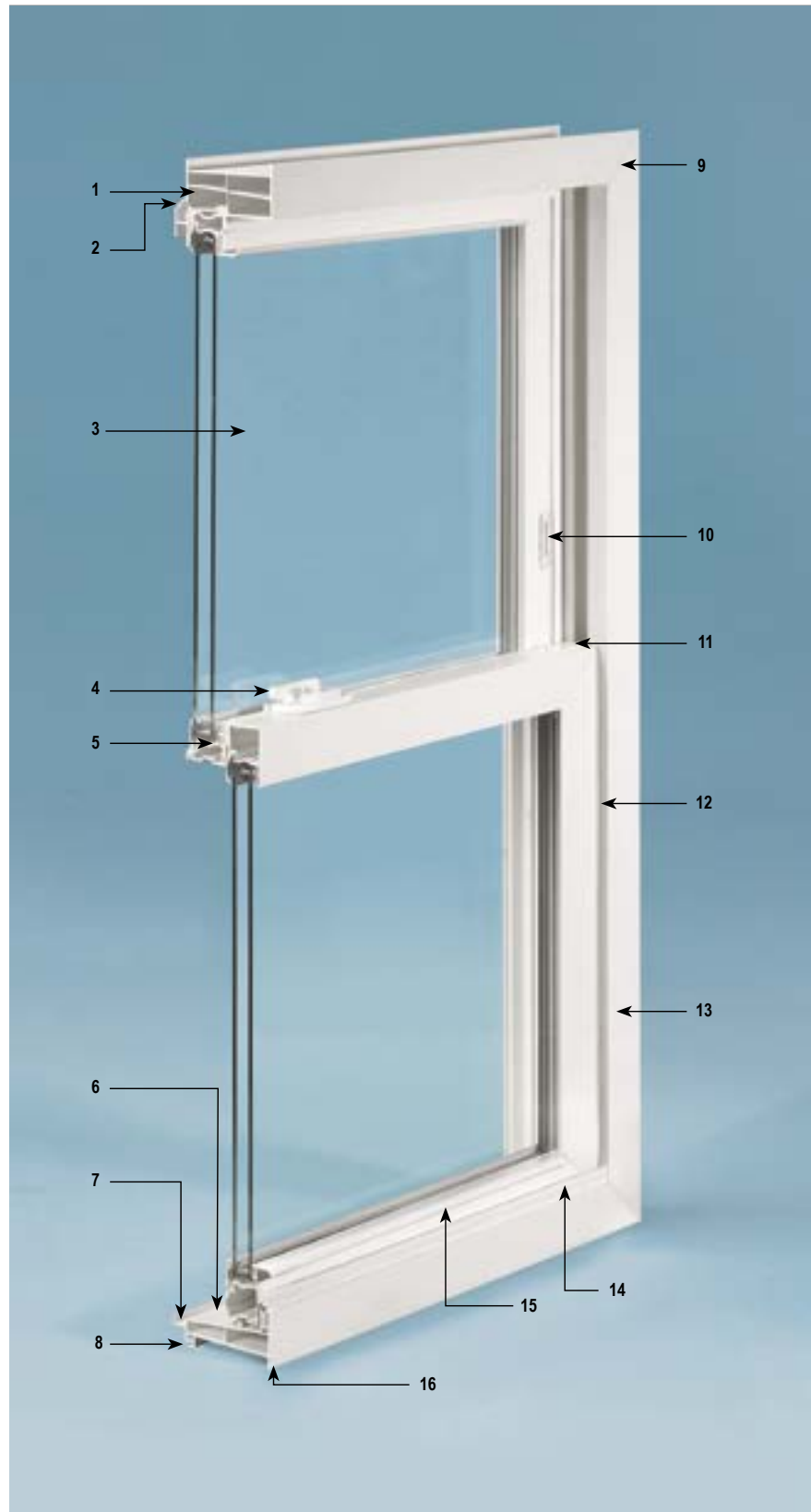

Cambridge Replacement Windows.

Available in all Viwinco styles, with any of our options.



Excellence. It's built into every detail of our Cambridge window. When we designed the vinyl frame profile, we prioritized robustness: manufactured with more PVC than the competition, multi-chambered and fusion welded, it provides a lifetime of durability and performance. The frame also offers top weatherability, color retention, and extremely low-maintenance. Unlike wood, vinyl never rots, chips or needs painting. In terms of glazing, the 15/16" double-strength glass package stands out for its superior insulating properties. Our **Tilt-n-Lock hardware**—standard on Cambridge hung windows—brings beauty, ease of use, and ingenuity together.

Cambridge windows come standard with some of the industries finest features. See pages 11-14 to learn more about color choices, simulated divided lites, and more.

Our Cambridge warranty includes LIFETIME GLASS BREAKAGE COVERAGE in addition to limited lifetime coverage on sash, frame, and hardware. For more details see www.Viwinco.com

Tilt-n-Lock HARDWARE

Exclusive Technology

- One-handed operation
- Clean sight lines
- Easier cleaning

Available on Cambridge single- and double-hung windows



Locked Position

Sash is securely locked. Hidden tilt latches are housed in sash channel for added strength.



Unlocked Position

At the 150-degree position, the hidden tilt latches are engaged with the jamb, and the sash can be lifted.



Tilt-In Position

When the lever is moved to 180-degrees, the hidden tilt latches clear the jamb channel, allowing the user to easily tilt the sash inward.



Premier Performance

Standard Features

1. Chambered, 100% virgin vinyl profiles add thermal efficiency and structural strength for superior performance
 2. Beveled exterior for a craftsman look and architectural appeal
 3. 15/16" Double-strength insulated glass unit with Low-E, thermally efficient spacer, and argon gas fill for top insulating value
 4. **Tilt-n-Lock*** hardware, standard on Cambridge single- and double-hung windows, provides strength where it's most needed—along the interlock. The reinforcement becomes the housing for the hardware that allows you to use the lock to tilt the sash in with just one hand. Tilt latches are not visible
 5. Sash interlock hooks the sashes together and to the frame on hung windows, providing increased thermal efficiency by blocking air from entering or escaping
 6. 5-Degree true sloped sill directs water and debris away from your home
 7. Screen track secures screen in place to better block insects
 8. Sill angle accessory pocket simplifies sill angle installation
 9. Fully fusion-welded frames and sashes for strength, durability and low-maintenance.
 10. Dual nite vents for increased control over air ventilation
 11. Unique triple weatherstripping for enhanced thermal efficiency
 12. Stainless steel, 3/4" constant-force balance eliminates sash drift and never needs adjusting
 13. Coextruded glazing bead around perimeter of glass is specifically designed with a flexible edge to ensure a weathertight fit
 14. 1-3/8" Weatherstripped, replaceable sill dam is mortised into the jamb, providing aesthetic appeal, ease of installation, and superior protection against drafts and water infiltration
 15. Molded-in, curved lift rails on both sashes make operation easy and comfortable
- Heavy-duty extruded locking half-screens are standard.

Cambridge single-hung windows are engineered with two sashes for equal sight lines and to match the look of a double-hung. Only the lower sash is operable.





Picture & Geometric Windows

Since picture windows are fixed units they provide some of the best thermal performance while offering the most viewing area. Our geometric department can create picture windows in many different shapes allowing pictures and geo's to be a popular choice for any build.

Style Options



Half-Round over
Double-Hung/
Picture/Double-Hung

Picture/
Picture/Picture

Double-Hung/
Picture/
Double-Hung



Circle



Elliptical



Half-Round



Extended-Arch

For additional shapes and grid options, visit our website.

Note: When geometric and picture windows are mullied together, sightlines will not be even.



Sliding Windows

Sliding windows (sliders) are designed with space in mind. They're particularly convenient for window spaces that are wider than they are tall. Easy to operate, sliders also offer trouble-free maintenance: just lift out the sash, spray, and wipe.

- Positive latching with adjustable keeper and cam-style lock
- Interlock on sashes for energy efficiency and durability

Style Options



2-Lite
(1/2-1/2)



3-Lite
(1/3-1/3-1/3)



3-Lite
(1/4-1/2-1/4)



Casement and Awning Windows

Casements are hinged at the left or the right, and they swing open to the outside with a turn of the handle. Awning windows are similar in design and functionality to casements but are hinged at the top and open outward. Multiple casements or awnings may be combined to create a window wall. We also offer a Colonial Casement (inset image). It's designed to look like a double-hung window with the egress features of a casement window.

Possible Combinations

Handing is viewed from the outside

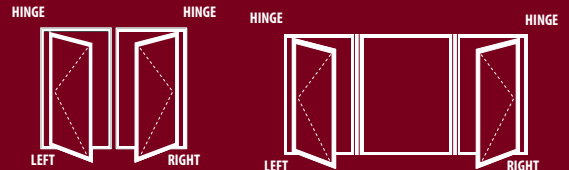

Twin Casement

Casement/Picture/Casement

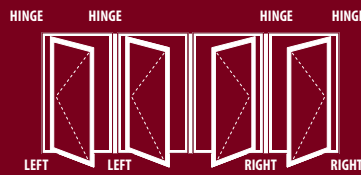

Combination Quad Casement

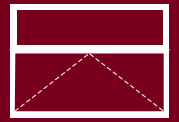

Transom over Awning
(Hinged at top)



Bay and Bow Windows

Bay and Bow windows project outward from the building envelope and provide a full 180-degree view of the outside. These seated windows create a sense of space and openness to any room making it seem larger and more inviting. Bay windows can protrude from the house at either 10-30-45 degrees while bow windows are always angled at 10-degrees.

Possible Combinations

Bay Windows



10° Bay
Casement/
Picture/
Casement



30° Bay
Double-Hung/
Picture/
Double-Hung



45° Bay
Casement/
Picture/
Casement

10° Bow Windows

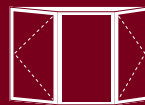

3-Lite Bow
Casement/Picture/
Casement



4-Lite Bow
Casement/Casement/
Casement/Casement



5-Lite Bow
Picture/Picture/
Picture/Picture/Picture

The abundance of **light** and the feeling of **inclusiveness**

created by large panes of glass makes any home feel more airy and look brighter. Viwinco's patio doors slide open smoothly to allow for easy indoor/outdoor access.

Patio Door Customization

- Vinyl sill is standard on 2-Lite, 3-lite, and 4-lite patio doors
- Grid patterns include colonial and prairie, in flat or deluxe styles. SDLs also available
- Knock-down assembly option available for all sizes for 2-lite, 3-lite, and 4-lite patio doors
- Blinds between glass available on select sizes for 2-lite, 3-lite, and 4-lite patio doors

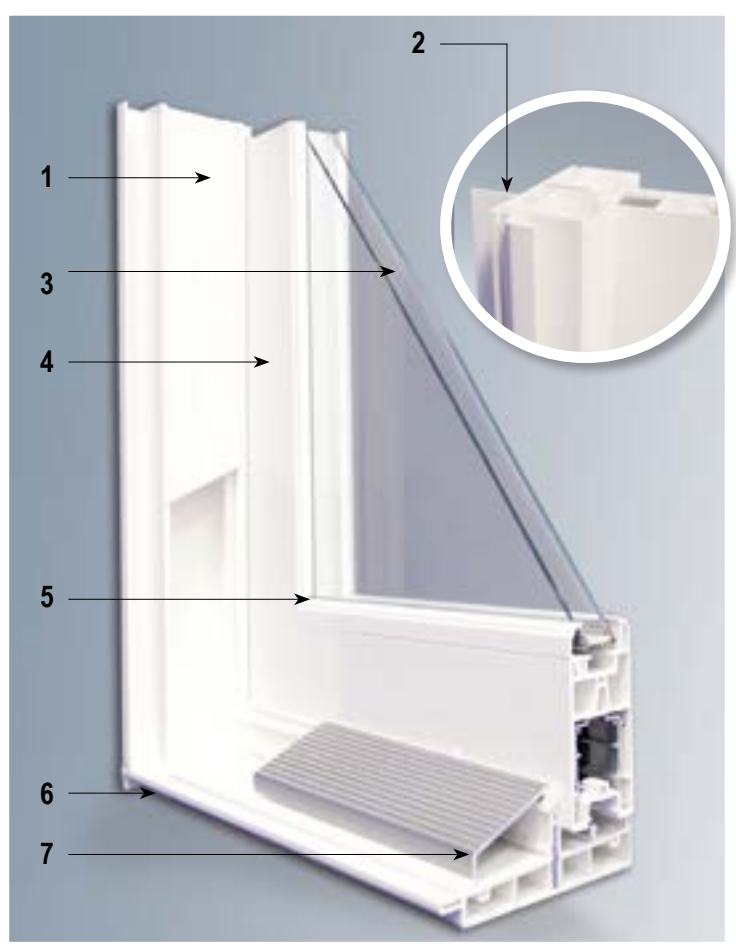

Patio Door Features

1. Head and jamb track covers for a finished appearance
2. Snap-in J-channel accessory is available to allow for a 3/4" or a 1-1/4" J-channel pocket for siding with a brick mold look on the exterior
3. 1" Tempered, double-strength, Low-E glass, thermally efficient spacer, and argon gas fill for strength and thermal efficiency
4. Precision-cut and fusion-welded frame creates a powerfully-built sliding patio door. 4" Stiles and a slim frame maximize the viewing area
5. Extruded glazing bead is mitered in the corners for a hand-crafted look
6. Independent screen track keeps screen in place during travel
7. Threshold cover keeps out dirt, grass and leaves

Patio doors are available with all of our color options. See pages 13-14 for option details.



Style Options

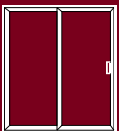

2-Lite
w/Transom

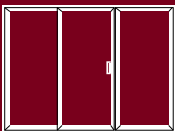

3-Lite
w/Transom

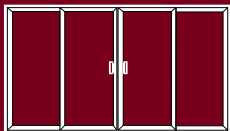

4-Lite
w/Transom

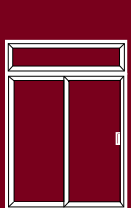

2-Lite
w/Elliptical

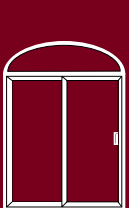

2-Lite
w/Half-Round

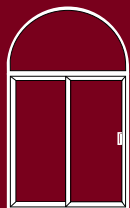

2-Lite
w/Half-Round

NEW Door Handle Options



Our new patio door handles will be used to replace our existing "D-Handle". These patio door handles feature a more-modern look, a two-point locking system and are comprised of heavy-duty components to ensure positive locking. The robust squared handle enhances the overall finish of the door with its sleek lines and ergonomic design. These handles contain the same punch settings as the D-Handle and can easily replace the existing handle if needed. The new locks may be either keyed or non-keyed.

Patio Door Handing Options

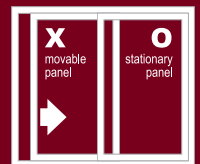

Left-Hand Operation
Viewed from outside

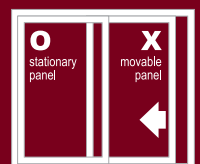

Right-Hand Operation
Viewed from outside

Options for every project.

Unparalleled quality. Viwinco provides it not only in our windows, but also in the details you choose to customize them. We have the options you're looking for, and maybe even some that will surprise you.

Product Line Option Availability							
Product Line	Structurally Mullered Units	Solid Extrusions	Exterior Laminates	Grids/Simulated Divided Lites	Specialty Glass	Brushed Nickel Hardware	Screens
EDGEMONT	✓	White/Tan (see p. 13)	--	Grids (see p. 13)	✓	--	✓
CAMBRIDGE	✓	✓	✓	✓	✓	✓	✓

Structural Mullions

Structural mullions provide increased integrity between horizontally and/or vertically adjacent mounted windows. A window-wall mull (integral mullion, below) is available for casements and awning windows. An H-Mull or horizontal mullion is used to mull Edgemont windows.



Structural Mullion used to mull two or more Cambridge units together. Interior view.

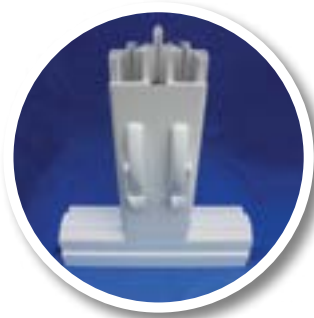

Integral Mullion (continuous head and sill) for mulling Cambridge casement, casement picture, and awning windows.



An H-Mull is used to mull Edgemont double-hung or picture windows.

Select Combinations

Available styles and combinations depend upon product line.

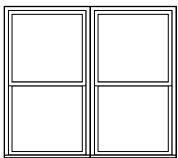

Twin Single- or Double-Hung

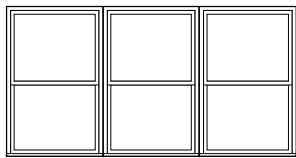

Triple Single- or Double-Hung

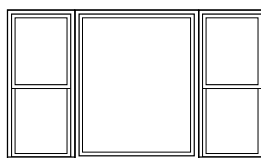

Double-Hung/Picture/Double-Hung or Single-Hung/Picture/Single-Hung

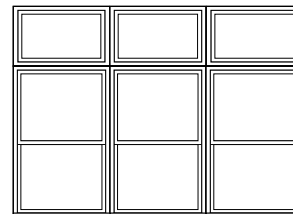

Triple Single- or Double-Hung with Transoms above (Cambridge only)



Windows and doors are one of the most eye-catching aspects of a home, and adding color is one of the easiest ways to add personality. Viwinco's exterior laminates do more than bring character to your home. They are the most robust and enduring you can find. Engineered to outperform some of the harshest conditions, our exterior laminates are proven to withstand the test of time while maintaining the bold colors you want. **Did we mention our laminates also provide exceptional thermal performance?** Our premium laminates are comprised of multiple thin layers that result in a finish that is highly resistant to harmful ultraviolet light and salty air (ideal for coastal applications). Durable, efficient, and bold, our exterior colored laminates are the perfect solution to adding personalization to any project.



VIWINCO COLORS

Available with white interior only

Offered on all Cambridge windows and patio doors.



Bronze



Midnight Black

- Triple-layer construction for exceptional durability
- More robust than paint: won't chip, crack, or fade
- Heat-reflective technology
- Impervious to the damaging effects of moisture and salt; ideal for coastal regions

Traditional Solid Extrusions

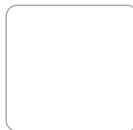

White



Tan



Clay

Cambridge:

White, Tan, or Clay.

Edgemont:

White or Tan only.

Simulated Divided Lites

Only available on Cambridge windows.

Achieve the classic look of authentic divided lites while enhancing your window's energy efficiency.

- Great for historic restorations
- SDLs permanently adhere to the inside and outside surfaces of the glass
- SDLs are offered in all of our solid extrusions and exterior colors



Grids

Grids add definition to your window and character to your home. Sealed between the glass for easy cleaning, they are available in two styles—flat internal or deluxe internal.

Windows with an exterior laminate are available with color-matched deluxe grids.



Deluxe top,
Standard bottom

Patterns

Colonial, Prairie, Double Prairie, Diamond (flat internal only), Queen Anne, Valance, or specialty designs.

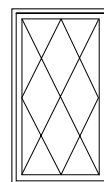

Diamond

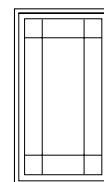

Prairie

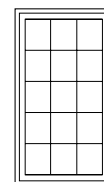

Colonial

Specialty Glass

Glazing options include gray tint or obscure glass. Tempered glass (not shown) is available for extra safety and is commonly used in high-traffic areas.

Gray-tinted glass can be chosen to reduce solar heat gain and glare or obscure glass can be used to increase privacy.



Gray-tinted



Obscure glass

Window Operating Control Device

We offer window operating control devices (WOCD) when required by code on our hung and casement products.



WOCDs for single- and double-hung windows



WOCDs for casement windows

Hardware Finishes

Your hardware finish will automatically match the interior color of your window. **Brushed nickel hardware is also available as an option** for any Cambridge window or patio door with a solid extrusion or exterior laminate.



For pictures of different finishes, visit our website at www.Viwinco.com

Casement Hardware

All casements and awnings come standard with stainless steel hardware for added strength and durability in addition to our new modern handle and lock for a sleek finished look.



Screens

Viwinco windows have two available screen options, extruded locking half-screen and extruded full screens. BetterVue® screening is standard on both screen options.

Extruded Locking Half-Screen: Locking screens can be securely locked in the up or down position. Only available on Cambridge.

Extruded Screens: Durable aluminum construction that's resilient, resistant to rust and won't warp or bow. Built to last the life of your window. Pull rails are located on all four sides, there are no pull tabs to obscure the view.

Cambridge windows come **standard** with our heavy-duty extruded locking half-screen and **Edgemont** windows come **standard** with an extruded half-screen. **Full extruded screens** are available as an **upgrade** for both **Cambridge** and **Edgemont** windows.



Heavy-duty extruded locking half-screen.

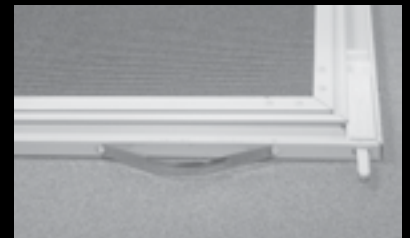

Extruded full-screen with reinforced corners.



One customer at a time. From idea to installation, we never lose sight of **you.**

Your home is a part of you. The comfort and beauty you create inside and outside reflect the life you are building for yourself and your family. Perhaps nothing is more important to your home's atmosphere than your windows.

They provide light, air, character, warmth—as well as the views that connect you to your surroundings. For over forty years, homeowners have counted on Viwinco's custom-made replacement windows to provide benefits ranging from top energy efficiency to curb appeal. Over those same forty years, our family-owned and operated business has grown into one of the most innovative and trusted in the industry.



851 Hemlock Road
Morgantown, PA 19543
610-286-8884 | www.Viwinco.com

REP100 Updated © 1/2023 Viwinco Inc.