



**PARADIGM**  
W I N D O W S

RESIDENTIAL SOLUTIONS

---



The Last Windows  
You'll Ever Need to Buy



**PARADIGM**  
WINDOWS

## Dream it...

Creating a home requires skill, understanding and vision. At Paradigm Windows, we recognize that your windows do more than allow light into your home, they frame the space in which you live your life. Paradigm's windows are designed by builders, architects and homeowners to create a product that provides industry leading performance, strength and beauty. By combining low maintenance windows with easy-to-clean tilt in sashes, state-of-the art insulating glass packages, an industry leading warranty and a wide range of styles, colors and trim options, we provide the tools you need to build your dream home. After all, we are... Paradigm Window Solutions For Life.



You can always rest easy, knowing that all Paradigm products are AAMA Gold Label certified, the highest level of certification by the fenestration industry.



# What You Need to Know Before Buying Windows...



## Making the Right Decision

When you are comparing different window brands be sure to review each product's testing information. Paradigm Windows products are tested by certified, independent laboratories that provide you with critical information that you need to make the best decision for your project.

We Meet or Exceed Standards of All Prominent Organizations That Set Performance Requirements for Windows.



### AAMA Gold Label Certification

Paradigm products are AAMA Gold Label Certified. To achieve this status, products must be tested by an independent, certified test lab to verify air, water and structural performance. All extrusions and components used must also be certified by AAMA to ensure they meet quality standards and insulating glass must undergo durability testing for its own certification.

As an AAMA certified manufacturer, we are required to maintain documented quality procedures, which are reviewed as part of unannounced in-plant inspections by AAMA.

All this ensures products of consistent high quality that will perform to the stated criteria when properly installed.



### NFRC Certified

The National Fenestration Rating Council (NFRC) provides certification of a window or door product's thermal performance.

Through a combination of laboratory testing and computer-based simulations, properties such as heat flow (U-factor), Solar Heat Gain, and visible light transmittance are accurately determined, and each product labeled with these values.

Random product testing by an independent lab verifies product conformance. The NFRC label on Paradigm products ensures you have accurate performance information when shopping for the best products for your home.



### ENERGY STAR® 6.0®

ENERGY STAR® is a program administered by the U.S. Environmental Protection Agency, which enables consumers to make informed choices about energy efficient windows and doors.

Using performance data obtained through NFRC certification, ENERGY STAR® establishes performance criteria that must be met for a product to qualify within designated climate zones.

Use of ENERGY STAR® products can reduce energy consumption, helping you save money while protecting the environment.

## Understanding The Parts of a Window

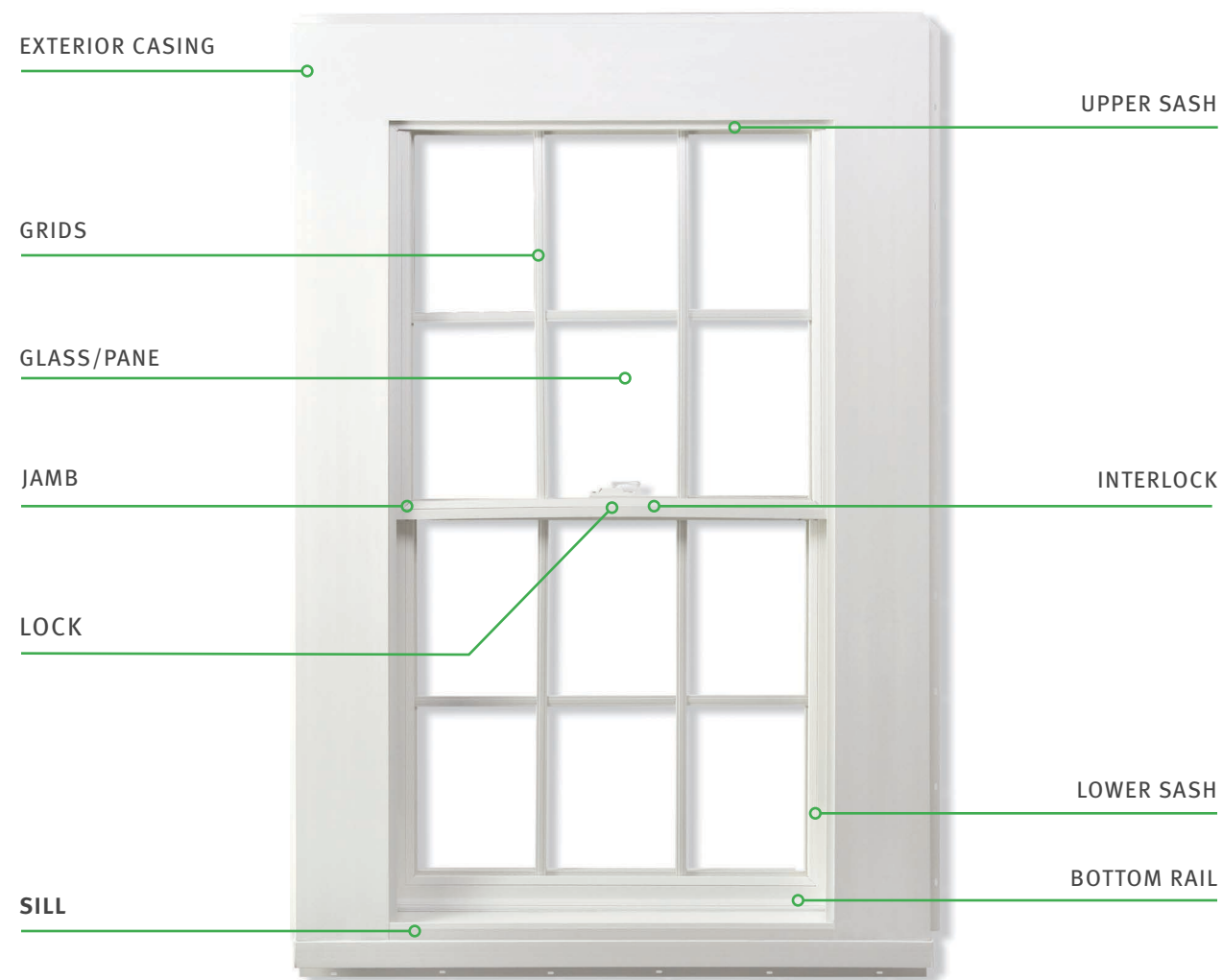

# Best-In-Class Spacer System

## Duralite® True Warm Edge Technology

A spacer keeps a window’s glass panes the correct distance apart. In some windows, the spacer in the window frame can be conductive, allowing valuable energy to escape. The Duralite® Spacer System reduces conductivity by 45% by eliminating metal components, allowing our products to maintain optimal thermal performance.

**Right Side Graphic** - Shows that our spacer system achieves a temperature of +21.4 degrees warmer than other spacer systems. If the temperature outside is 0 degrees, and the interior temperature is 70 degrees, the “touch” temperature of the glass would be 46.6 degrees. This keeps the warm air in, maintaining a more consistent interior temperature.

## Spacer Comparisons

up to **+21.4°F** warmer temperature at the edge of the glass

Outside 0° F  
Inside 70° F

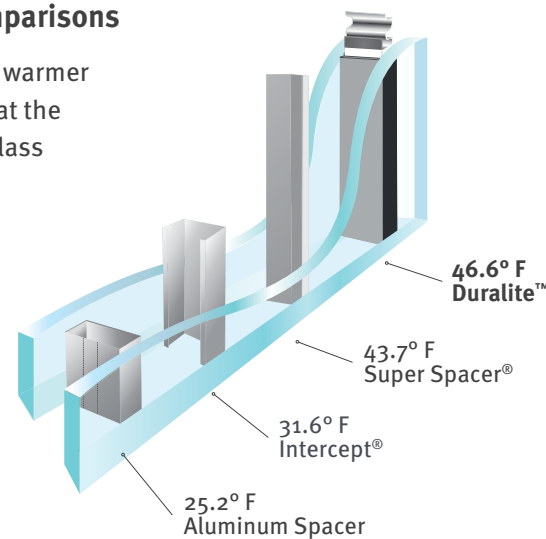

# Glass Types

## What is Low-E glass, and what does it mean?

Low emissivity (Low-E) glass employs a high-performance coating designed to selectively reflect thermal and visible wavelengths. This allows the insulating glass (IG) to reflect heat back toward the warm side (interior in winter, exterior in summer), while providing a clear view and natural light. The placement of this Low-E surface within the IG can affect performance factors, such as solar heat gain, allowing for customization based on regional climates or sun exposure. Gas fill, such as Argon, is sealed within the IG which reduces convection to provide a better insulating value.

### Low-E 270 with Argon

This glazing package incorporates a Low-E coating on the sealed side of the exterior pane, and argon gas fill. This allows the reflection of radiant heat with some limited solar heat gain. **Good for year-round insulating value, without excessive solar heating in summer months.**

### Reverse Low-E with Argon

Similar to Low-E w/Argon, but with the Low-E coating on the sealed side of the interior pane. This provides the same radiant heat reflection with increased solar heat gain. **A good choice for primarily cold weather climates where benefits of added solar heat in winter outweigh the need for cooling in the summer.**

### Low-E 270/i89 with Argon

This package provides 2 Low-E surfaces, on the sealed side of the exterior pane and the room-side of the interior pane. This combination provides heat reflection from both panes, with some solar heat gain. **A thermally improved option good for a wide range of climates.**

### Triple Pane Low-E with Argon

Triple pane Low-E offers 2 panes of Low-E, on the sealed side of the interior and exterior panes, with an added pane of clear glass in between. This provide 2 sealed, argon filled cavities for added insulation. Solar heat gain is moderate, **so this is also suitable for high insulating value in a variety of climates.**

Paradigm Window Solutions offers many glass package options to achieve performance standards specified by you! For more information on other glass packages, contact a Paradigm representative, or distribution partner.

## Compare Glass Types - Energy Savings

INSULATED GLASS SYSTEMS						
	Window Type	Glass Type	U-Factor	SHGC	VT	CR
<b>3/4" LowE, Clear with Argon</b> <i>(Meets ENERGY STAR 6.0 with Foam Fill)</i>	Double Hung	Standard LowE w/Argon	0.27	0.28	0.53	61
	Slider	Standard LowE w/ Argon	0.27	0.28	0.52	62
	Casement	Standard LowE w/ Argon	0.26	0.25	0.47	62
	Picture	Standard LowE w/ Argon	0.25	0.33	0.62	63
<b>3/4" LowE 270/i89 with Argon</b> <i>(Meets and Exceeds ENERGY STAR 6.0)</i>	Double Hung	Double LowE w/Argon	0.24	0.27	0.51	51
	Slider	Double LowE w/ Argon	0.24	0.27	0.51	50
	Casement	Double LowE w/ Argon	0.24	0.25	0.46	50
	Picture	Double LowE w/ Argon	0.21	0.32	0.60	50
<b>3/4" LowE 180/i89 with Argon</b> <i>(Meets and Exceeds ENERGY STAR 7.0)</i>	Double Hung	Double LowE w/ Argon	0.25	0.48	0.58	46
	Slider	Double LowE w/ Argon	0.26	0.47	0.58	46
	Casement	Double LowE w/ Argon	0.25	0.43	0.52	46
	Picture	Double LowE w/ Argon	0.22	0.55	0.68	47

Note: All values shown are for non-reinforced products with single strength glass and no grids.

**U-Factor** - U-Factor is the rate of heat flow through the window product (BTU/hr-ft<sup>2</sup>-°F). A lower number is more energy efficient  
**SHGC** - Solar Heat Gain Coefficient (SHGC) represents the amount of solar radiation admitted through the window. A lower number transmits less solar heat to the interior.  
**VT** - Visible Transmittance (VT) is a measure of how much visible light passes through a window. Higher numbers will provide more natural daylighting, lower numbers provide more shading.  
**CR** - Condensation Resistance (CR) measures a window’s resistance to the formation of interior condensation. A higher number provides better condensation resistance.



## Introducing NEAT+™ Glass - Keep Your Windows Clean..Longer

NEAT+ includes an innovative, invisible coating technology that is applied on the exterior surface of the window. NEAT+ is more conductive than uncoated glass as it dissipates static, resulting in a reduction in the amount of dust and dirt on the window’s surface. The coated layer reacts chemically with the suns UV rays and rain to breakdown greenhouse gases and other pollutants causing organic material on glass to decompose, keeping your windows naturally cleaner.

Test results from an outside lab show 40% less dust on the NEAT+ surface compared to uncoated glass, keeping the window cleaner longer. The result to the homeowner is fewer needed resources like water and cleaning chemicals, which save time, money and the environment.

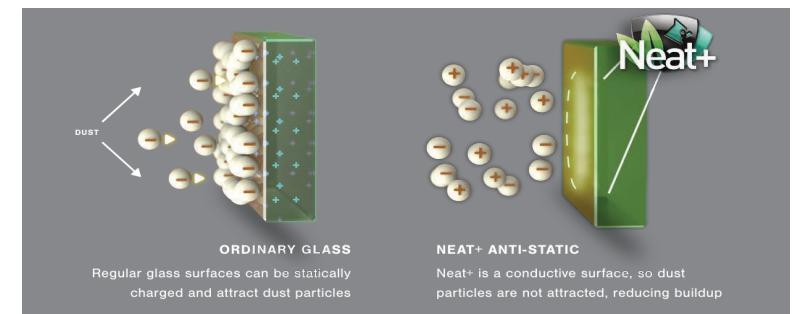

Image Credits -Simulations performed by Enermodal Engineering Ltd. using Window 5.2 and Therm 5.2 as per NFRC100-2001. Outside temperature 0°F, inside temperature 70°F. Low-E glass Cardinal Low-E 272. Air spaces .500" wide, 90% argon fill. IGUs 24" x 48". The secondary used with Intercept® was 0.035" thick. Super Spacer® is a registered trademark of Quanex Building Products. Intercept® is a registered trademark of GED Integrated Solutions. XL Edge™ is a trademark of Cardinal Glass Industries. [EIG10005W - EIG906wk/EIG10009W]. NEAT+™ is a registered trademark of Cardinal Glass Industries® Technical Performance Data NFRC 100 & 200. January 2021

# Why Choose Paradigm?

## Built To Last a Lifetime...Ultimate Peace of Mind

Paradigm Windows manufactures windows and doors that are built, verified and tested to exceed industry standards. Our custom made, premium vinyl windows and doors perform in the most diverse of climates. Our industry-leading warranty covers lifetime materials and parts, and 5 years of labor.

## Hassle-Free

Innovative design provides design flexibility, including additional options and accessories that ensure our products are easy to install, operate and clean – quality you deserve at a value you'll appreciate.

## Everything is Custom Built To Your Specifications

We use premium virgin vinyl because it resists fading, cracking, peeling and rotting. Additional options and accessories include multiple exterior casing styles, grids, screens, locks and glass options.

# Warranty

## Backed by an Industry-Leading Warranty and Support

The best windows and doors deserve the best warranty. And that's exactly what we deliver. Your custom window products are all backed by our Lifetime Materials Warranty which includes five years of labor. So, whether you choose from our 8-Series premium product line or from our 5-Series standard product you can rest assured, you have chosen wisely.

Our lifetime warranty covers the entire window, and it's fully transferable without a transfer fee to a second property owner. And when we say entire window, we mean it.

Those who choose to use the FlexScreen™ product, screen warranties must be registered by the homeowner through FlexScreen™ at <http://www.flexscreenwarranty.com>.

## WARRANTY COMPARISON

Features	Andersen	Marvin Wood	Pella Wood	Pella Vinyl	Harvey	Paradigm
Insulated Glass	20	20/10	Limited Life	20	20	Limited Life
Frames and Sash	10	10	Limited Life	Limited Life	Limited Life	Limited Life
Hardware and Components	10	10	10	Limited Life	Limited Life	Limited Life
Exterior Finish/Paint	10	10	2	10	10	20
Labor	0	0	2	2	0	5
Transferability	20	20/10	10	20/10	20	20

Competitor Warranty Information: Andersen Windows, Inc. Limited Warranty 2022, Andersen is a registered trademark of Andersen Corporation. Marvin Window and Door Limited Warranty 19913555, 2022. Marvin is a registered trademark of Marvin Lumber and Cedar Company (Marvin). Pella Wood Window and Door Limited Warranty WPW0614, Pella is a registered trademark of Pella Corporation. Harvey is a registered trademark of Harvey Building Products. FlexScreen is a registered trademark.



# The 8-Series Product Lineup

# The 8-Series Double Hung

At Paradigm Window Solutions, we understand the importance of quality and value when it comes to one of your most valuable asset – your home. We’ve designed a series of premium vinyl windows to capture the look of traditional windows. Our contoured narrow-line exterior mainframe adds striking curb appeal to your home along with the beauty, craftsmanship and efficiency you deserve.



## 8-Series Double Hung Window Features

### .070 NOMINAL WALL THICKNESS

Extrusion walls are made up of high quality virgin PVC, providing superior structural integrity.

### FUSION WELDED FRAME AND SASHES

Industry-standard fusion welding system for clean, precise lines and improved structural strength.



Shown - 8300 Premium Double Hung - Exterior White with 3-Sided Casing

### EQUAL SIGHT LINE SASHES

Top and bottom sashes are equal for cleaner sight-lines. Equal sight lines increase the visible glass area maximizing the amount of light that comes through the window.

### SLOPED SILL WITH I-BEAM CONSTRUCTION

Proprietary sill design allows for increased water protection and added strength.

### EXTERIOR GLAZING WITH INTEGRAL LIFT RAIL

Clean sight lines from the interior side for an architecturally correct look.

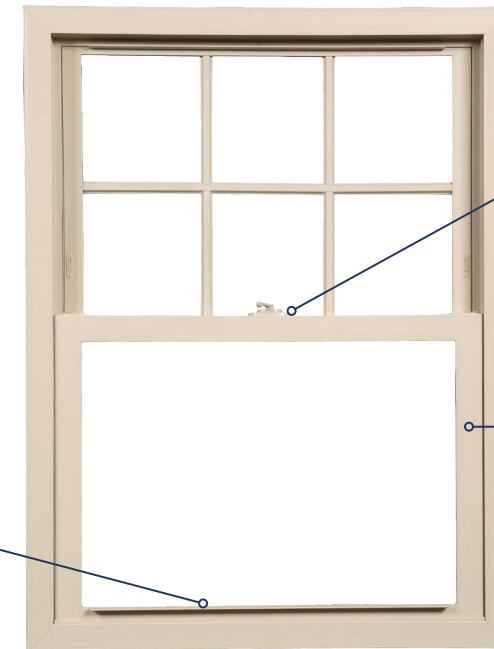

Shown - 8300 Premium Double Hung - Painted interior Tan

### COLOR MATCHED HARDWARE

All hardware can be color matched to complement your interior color choice.

### FULL INTERLOCK AT UPPER AND LOWER MID-RAIL

Creates one of the tightest seals from the outside in the industry, helping to keep air from escaping out of your home.



### EXCEPTIONAL INSULATING GLASS

Standard glass includes 3/4" Insulated glass unit with Low-E/Argon for superior thermal efficiency. Many glass options available.



### DURALITE® WARM EDGE SPACER SYSTEM

Polycarbonate design contains no metal and is known as the most energy efficient spacer system on the market.



### PROPRIETARY BALANCE CAVITY AND BALANCE COVER

Reduces air infiltration between the frame and integral components for a tight seal and a clean look.



### TILT-WASH CAPABILITY

Tilt function for both sashes for easy cleaning



### FULLY INTEGRATED COMPONENTS AND TRIPLE WEATHER STRIPPING

Keeps air leakage rates as low as .04cfm/sf - among the lowest in the industry. T-slot weather stripping design allows for easy repair and replacement.



### STAINLESS STEEL CONSTANT FORCE BALANCE

Is a mechanism hidden inside the balance track that ensures smooth and effortless fingertip operation to open and close your windows.



### OPTIONAL FOAM FILLING

High density polyurethane insulated frames and extrusions provide additional energy savings.

### AVAILABLE 8 - SERIES WINDOW TYPES

Double Hung, Single Hung, Casement, Awning, Hopper, Slider, Picture, Specialty Shapes and Bays and Bows.

# Slider

Homeowners seeking to maintain a greater level of comfort at home can rely on Paradigm's sliding windows which are designed to guard against harsh weather elements and look great.

For draft-free comfort, easy operation and solid performance our sliding windows get the job done!



## Sliding Window Features

- › Unique lift-out sash design makes cleaning easier.
- › Lift-out sashes have twin tandem brass rollers for easier operation.
- › Draft-free comfort is ensured by having the sash encapsulated into the frame.
- › Extra weather-stripping provides extra comfort and maximized energy efficiency.
- › Diverse options for peak ventilation includes the two-section slider or the three-section slider with center or end vents.



Three lite slider configuration 1/4 - 1/2 - 1/4



Three lite slider configuration 1/3 - 1/3 - 1/3

# Casement & Awning

For a beautiful, open view from your home, Paradigm's casement and awning windows offer a unique blend of charm and elegance. Three continuous seals of weather-stripping around the window's perimeter provide a barrier to help eliminate drafts and delivers ultimate comfort. Custom design enhancements offer the style and versatility you desire.

## Casement & Awning Features

- › Ergonomic hardware allows casement windows to open to a 90-degree angle allowing the exterior pane of glass to be cleaned from inside the home.
- › Low profile single lever multi-point locking system for secure and easy operation.
- › Triple weather-stripping for airtight thermal performance.

## Casement Hardware

Contoured low profile handle provides an unobstructed view of your new windows. The operating handle folds in for a clean look.



# Bay & Bow

Paradigm's bay and bow windows bring more sunlight to a space, both inside the home and from exterior viewpoints. They're a great way to add more space on the inside and beautify your home on the outside. Bay and bow windows let you feel the breeze outside whenever you want with operable end units. Optional colors, inside and out, plus many glass selections to enhance the beauty of these window styles.



## Bay & Bow Features

- › High quality seat boards, headboards, and side jambs are manufactured from 1 1/2 " thick insulated high quality birch veneer plywood versus competitor's 3/4 " thick plywood.
- › Interior head and seat boards of bay or bow windows can be stained or painted to match your decor.
- › Anti-water system to help protect against unwanted water and moisture.
- › Bay angle: Available in 30° or 45°
- › Bow angle: 10°



### Furniture Finish

The insulated head and seat board features a high quality birch veneer finish with matching edge banding.



### Cable Support System

A factory installed cable system ensures the strength you need for proper support and installation.



- ▼ This bay window features colonial grids in the center and flanked by premium double hung windows with colonial grids in the top sash.

◀ This bay window features a sandstone exterior with premium double hung windows on each side.



- ▼ This 5-lite bow window features sable exterior color with matched sable colonial grids, and four operating casement windows.





# Sliding Doors

## A Beautiful View

Paradigm Sliding Patio Doors are the perfect complement to your home's unique character and the design style you're creating. It's more than an entrance or exit, it's a beautiful view of the outside world.

Dependable security, beauty, high durability and easy operation are just a part of the inside story on how Paradigm has created a good idea into a great sliding door.

Fully interlocking panels glide on dual tandem rollers for smooth operation. Energy saving climate control glazing insulates against heat and cold year-round, so when you tear yourself away from the great outdoors, you'll find it's great indoors, too.



## Sliding Door Features

- › Fully welded panels and frames for superior strength.
- › 1" thick high performance tempered insulated glass.
- › Dual tandem heavy duty sliding panel rollers.
- › Easy slide locking screens with adjustable rollers.
- › Three-point locking system provides greater security.
- › Vinyl thermal break in the sill minimizes heat transfer.
- › Sliding doors ship assembled and factory adjusted.



Optional flush bolt on 4 panel doors holds the operating panel in place as an additional locking point for added security.



Every Paradigm door incorporates a concealed three-point locking system, which is recessed in the door panel. Three locks simultaneously engage with the door jamb when the door is closed and locked.

Paradigm Sliding Doors are available in 2, 3 and 4 panel options, in both stock and custom sizes.



## Blinds Between The Glass For Sliding Doors

Built-in blinds with fingertip control of privacy and natural light offer all the benefits of typical blinds, without the dusting or swinging of cords. There are no surfaces for allergens to collect; and blinds are protected from excited pets, curious toddlers, and the occasional soccer ball. Limited availability in white only. Our between the glass blinds include a 10-year warranty.



Choose from eight handle set finishes with optional keyed lock-set.



# Geometric

## Picture Windows

The 8-Series picture window provides the perfect panorama for your favorite setting; your home. In fact, you can almost think of our picture window as a wide-screen movie formatted to full screen for your viewing pleasure!

Picture windows are available in 6 different configurations, and can be made to match your operable window choice.



- › Beveled Picture    › Deadlite
- › Geo Picture        › Sidelite
- › Casement Picture › Transom

## Geometric Windows

Paradigm’s geometric windows let you complete the distinction to your home’s exterior view, while allowing you to capture more of the world around you. Our geometric shaped windows aren’t just beauty in the eyes of the beholder; they’re beautifully energy-efficient as well.

From the simple to the sublime, you can select both shape and size to create your own home’s personality and points of interest, or simply to grace a special space with sunlight.

You’re the designer and we’re here to help you round out your creation.



## Geometric Styles

- › Full Circle
- › Eyebrow with extended legs
- › Quarter round
- › Circle top
- › Octagon
- › Triangle
- › Circle top with extended legs
- › Trapezoid
- › Eyebrow
- › Pentagon

# Labor Saving Features

## Designed with Time Savings in Mind



### FACTORY APPLIED INSTALLATION OPTIONS

#### Casings

Architecturally correct casing styles include 3 1/2” Flat, 2 1/4” Brickmould and 5” Brickmould. Available in 3-sided with sill nosing or 4-sided picture frame styles. Casings come with a built in nail-fin and 1 inch J-channel pocket for seamless frame integration.

#### Factory Mulling

Factory applied and structurally rated; our various mulling options provide cost savings for any project. True and simulated stud pocket mull styles are also available vertically in 2” and 3 1/2”.

#### Built-in Features

To make installation easier all windows and patio doors include integrated nail fins and J-channel

#### Crown Moulding

Pre-cut and finished to be applied with exterior cased units. Continuous J-channel for ease of siding application. Sent as a separate piece and applied in the field.

#### Interior Receivers

Factory applied channel to receive drywall. Available in 1/2” 5/8” and 3/4”.

#### Extension Jamb

Factory applied wooden frame that fills the depth of the wall space from the inside face of the window frame or “jamb” to the face of the plaster or gypsum wall. Available in primed, clear, PVC & oak.

### FOR REPLACEMENT PRODUCTS

Aesthetically pleasing lines provide a true-to-wood look. Replacement models include 4 jamb adjustment screws and rigid frame for easy installation.

# Mulling

The process used for joining windows is key to the performance of any multi-window system. Paradigm's Mulling systems provide strength and performance unmatched by other offerings.

Our stainless steel plate and L-brackets form a joining system strong enough to withstand harsh object impact testing. Built with clean lines, unparalleled strength and design flexibility our structural mulling options fit most design requirements.

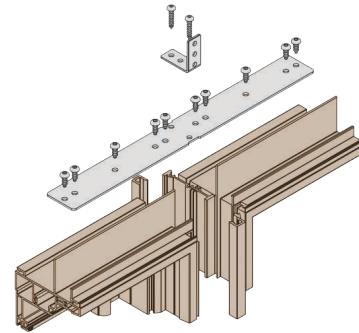

## STANDARD MULLING

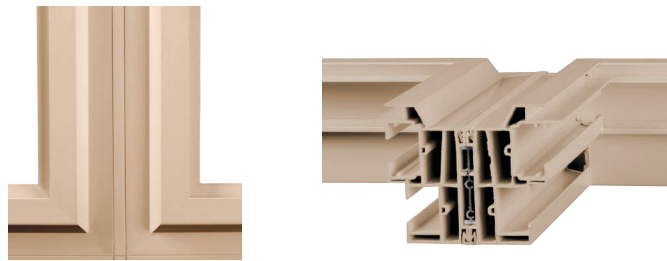

Directly joins products without adding to total frame size. Employs aluminum stiffener, full-length interior and exterior vinyl clips, and high-strength structural sealant.

## STUD POCKET MULLING

Vertical mulls only. Both single-sided and double-sided stud pocket mulls are available in 2" and 3 1/2". Single sided stud pocket mull is joined at the exterior with a full length, multi-chambered vinyl extrusion, while the double sided stud pocket mull is joined at the interior and exterior with added reinforcement and foam insulation.

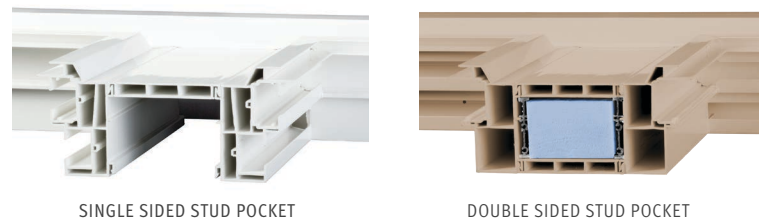

Photo provided by Robie Exteriors - 2020

# Designer Grid Options

Grid options enhance your window's beauty and style. Paradigm offers a variety of the distinct grid styles shown below.

## Simulated Divided Lites (SDL)

Instead of grids between the glass, choose Simulated Divided Lites to maintain your home's classic character. Have all the advantages of premium-performing windows with thermally-efficient insulating glass, plus the timeless beauty of grids on both the interior and exterior panes of glass. SDL is available in all of Paradigm's color combinations.



## Grids Between The Glass (GBG)

Grids are installed in between the panes of glass. This grid type offers a smooth interior, making the window easier to clean. GBG is available in many configurations, making this grid type a great solution for any style or design requirement. GBG can be painted to match or complement your window color choice.

Grids between the glass (GBG) and simulated divided lites (SDL) are available in both standard and wide widths.

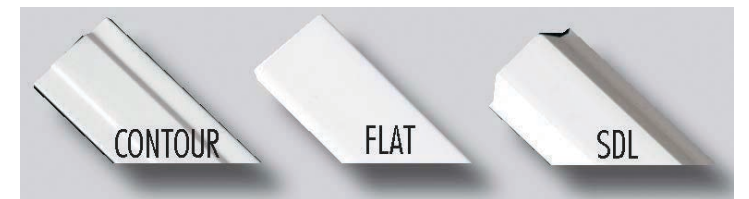

## Grid Configurations

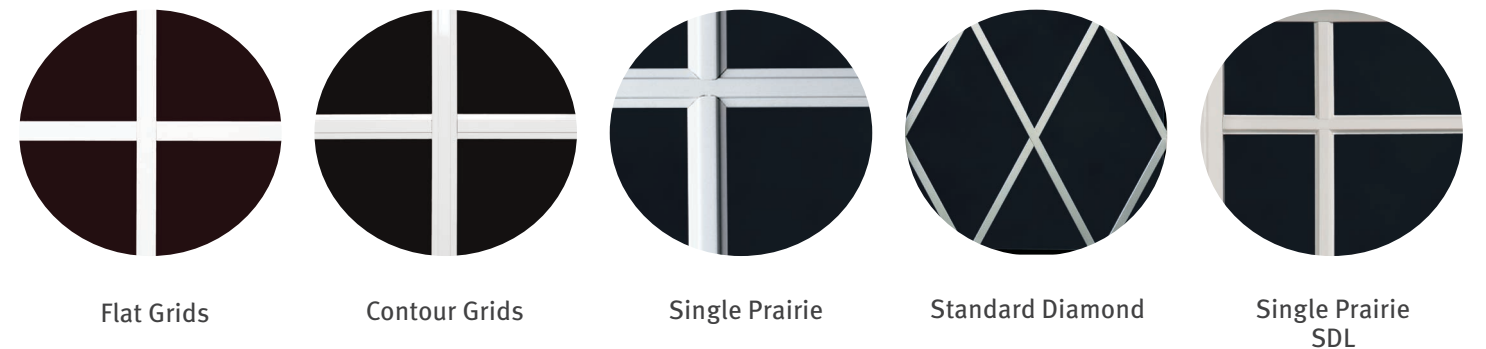

# Screens

## FlexScreen™

Designed to provide ultimate flexibility, durability and visibility this screen aligns with our hassle-free design making our products easy to operate and clean.

Like our windows, FlexScreen™ is designed to withstand extreme weather. This flexible frame is nearly indestructible, scratch resistant and hides within the screen pocket which eliminates the need to match paint.

FlexScreen™ is available on double hung, single hung and horizontal slider window types, in full or half screen configuration. Locking screen is not available.

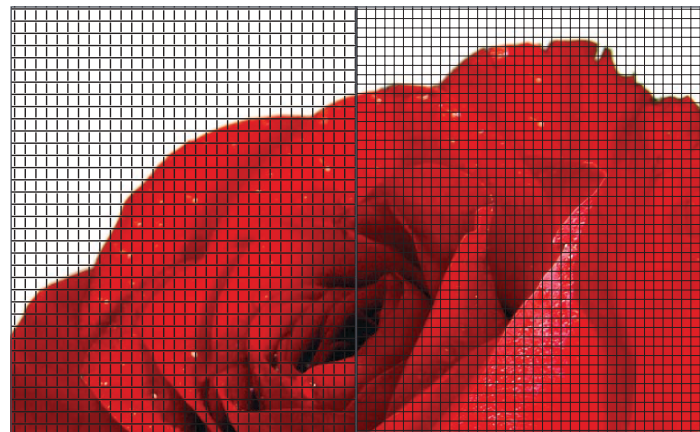

Standard Screen

vs.

VistaVu™

## VistaVu™ Screen

VistaVu™ insect screening for windows and sliding doors is an excellent visibility screen designed to maximize your outward view. VistaVu™ is woven from small, refined yarns that improve the screen's openness, making visibility sharper and more brilliant. Think of it as "high definition" insect screening for your windows and sliding doors. With VistaVu™, you see the clear and vibrant view, not the screen.

VistaVu™ screening is available as an option on 8-Series windows and sliding doors.

## Other Screen Options

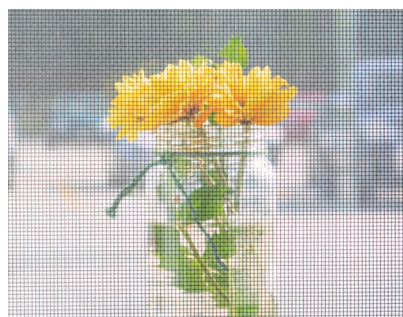

Aluminum Mesh Screen



Standard Fiberglass Screen

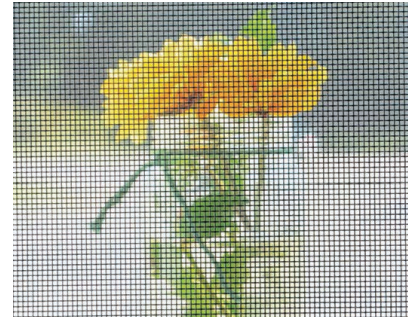

Vandal Resistant Screen (Available for special order)

# Jamb Extensions and Exterior Casings

## Interior Jamb Extensions



Interior Receiver Only



Clear Pine 6 9/16" Depth



Primed Finger-jointed 4 9/16" Depth



Primed Finger-jointed 6 9/16" Depth

## Exterior Casings

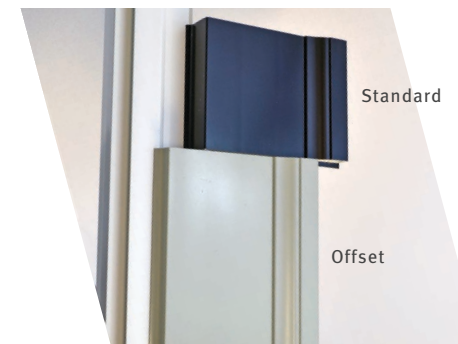

All casings are available in both offset and standard styles.



Crown Mould with 5" Brickmould



Flat Casing - 4 Sided



Brickmould - 4 Sided

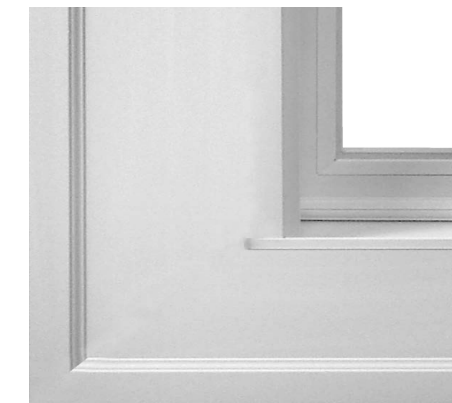

5" Brickmould - 4 Sided



5" Brickmould with Sill Nose

# Locks and Hardware

## Hung and Slider Window Lock Options



Black



White



Tan



Brushed Nickel



Oil Rubbed Bronze



White Composite Lock

## Casement Hardware



Black



White



Tan



Brushed Nickel



Oil Rubbed Bronze

## Sash Limiter and Security Options



Common Sash Stop



Vent Stop (In Jamb)



Vent Stop (In Sash)

# Colors

You're the artist, with a range from white to black. In fact, Paradigm makes available 7 optional stock colors that you can choose for the interior or exterior of the window.

## Finish Options

White Vinyl

Tan Vinyl



Cameo



Clay



Sable



Forest Green



Anthracite Grey



Bronze



Black

Printed images may vary from exact product colors and finishes. Please see your Paradigm dealer for exact color and finish samples.

# 5-Series Window Line

## Designed For Higher Performance - Re-imagined For Your Home Project

Our 5-Series window product line offers the opportunity for the more cost conscious to choose from many of the same energy saving features while making certain your new construction or remodeling project stays within budget.

Available for both new construction and replacement projects, the 5-Series double hung window provides performance, strength and beauty while offering excellent value. The 5-Series' durable multi-chambered fusion welded frame and sash provide superior energy efficiency. 5-Series products are backed by an industry-leading warranty and the local sales and service support you expect from Paradigm.



Available in Double Hung, Picture and Slider Window Types Only



### Available Egress Sizes

- > 36.5in x 61in
- > 37in x 61.5in
- > 37.5in x 59.5in

<b>U Value</b>	<b>SGHC with Grids</b>	<b>SGHC No Grids</b>
<b>.28</b>	<b>.33</b>	<b>.36</b>

Climate Zone	U-Factor	SHGC <sup>2</sup>	
Northern*	≤ 0.27	Any	Prescriptive
	= 0.28	≥ 0.32	Equivalent
	= 0.29	≥ 0.37	Energy
	= 0.30	≥ 0.42	Performance

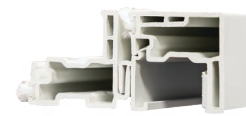

### Interlock

Full interlock system at the meeting rail improves security while several contact points of weather-stripping reduce air infiltration.



### Vinyl Profiles

Multi-chambered vinyl profiles maximize viewing area and energy performance while providing superior strength and durability. 5-Series double hung meets a PG-35 rating for air and water infiltration and deflection.



### Locks

Low profile composite ergonomic sash locks ensure smooth, easy and secure locking.

Colors - Available in White Only



### Available Options

- > 3 1/2" Exterior flat casing with sill nose (white only)
- > (3/4") Interior extension jamb receiver
- > Factory applied extension jambs (primed only)
- > Factory mulls and reinforced mulls
- > J channel filler
- > Vent stops

### Grid Options



- > Colonial, queen anne and prairie styles available
- > Grids between the glass
- > Flat
- > Contour



Property photos provided by Chinburg and Artform Architects - 2018



# PARADIGM

W I N D O W S

56 Milliken St. | Portland, Maine 04103

---

**877.994.6369**  
**paradigmwindows.com**



©2023 Paradigm Window Solutions. All Rights Reserved. Paradigm Window Solutions is a registered trademark. ENERGY STAR® is a registered trademark of the U.S. Department of Energy. NFRC® is a registered trademark of National Fenestration Rating Council®. Paradigm Window Solutions as the manufacturer, reserves the right to change information, performance data and any other specifications at any time.

Updated: 6/2023