



**INTEX**<sup>®</sup>  
MILLWORK SOLUTIONS



# Product Catalog

# 2023

[intexmillwork.com](http://intexmillwork.com)

# INTEX Millwork Solutions PRODUCT CATALOG



## Understanding Icons & Page Types



**SECTION INTRO PAGES:**  
A high-level break down of the standard offerings for our core products – most affordable, mid-grade and premium, followed by a custom option.



**HOW TO ORDER PAGES:**  
A handy checklist with easy-to-follow steps to help guide you through the ordering process.



**PRICE KEY:**  
Shows lowest to highest price point.



**INSTALL KEY:**  
Shows range from DIY-friendly to craftsman level installation.

### SECTION 01: RAILING SYSTEMS page 3

- How to Order Extruded Rail Kits ..... 5
- Liberty Rail..... 6
- Hampton Rail..... 8
- Providence Rail..... 10
- Dartmouth Rail ..... 12
- Nautilus Custom Rail ..... 14

### SECTION 02: RAIL UPGRADES page 16

- Decorative Panels ..... 16
- Radius Rail..... 20
- Gates ..... 21
- Black Baluster..... 22
- Drink Rail ..... 23
- 3-Line & Mahogany Rail..... 24
- Glass Infills ..... 25
- Louver Infill & Accessories ..... 26
- Horizontal Balusters..... 27

### SECTION 03: NEWEL WRAPS page 29

- How to Order Newel Wraps..... 31
- Structural Post ..... 32
- Fabricated Newels ..... 33
- Lighted Newel Caps ..... 34
- Millwork Newel Wraps ..... 35
- Millwork Newel Caps ..... 36
- Custom Newel Wraps ..... 37

### SECTION 04: COLUMN WRAPS page 38

- How to Order Column Wraps ..... 39
- Knocked Down Easy Wraps..... 40
- Assembled Easy Wraps..... 41
- Millwork Column Wraps..... 42
- Parametric Ordering..... 43
- Custom Column Wraps ..... 44

### SECTION 05: PERGOLA SYSTEMS page 45

- How to Order Pergolas ..... 47
- Classic Pergolas ..... 48
- Deluxe Pergolas ..... 49
- Premium Pergolas ..... 50
- Custom Pergolas ..... 51
- Trellis Systems ..... 54

### SECTION 06: MILLWORK & MORE page 56

- Estate Fence..... 57
- Shower Enclosures ..... 58
- Window Boxes & More ..... 59
- Shutters ..... 60
- Hollow Brackets & Rafter Tails ..... 62
- Additional Applications..... 64
- Mouldings, Trim, & More ..... 66
- For the Architect ..... 67



**RS60 LIBERTY EXTRUDED RAIL**  
Easy installation similar to routed vinyl rail, with the fit and finish of traditional wood rail.

- Rated for 10ft residential & commercial level spans
- Rated for 10ft residential stair spans
- Rated for 8ft commercial stair spans

✓ 1-1/4" Square-Edge, Hollow Balusters

**PRICE RANGE:** [Icons: 1 gold, 1 silver, 1 bronze, 1 white]

**INSTALLATION:** [Icons: 1 wrench, 1 screwdriver, 1 hammer, 1 saw]



**RS40 HAMPTON EXTRUDED RAIL & RS70 PROVIDENCE EXTRUDED RAIL**  
Screw-together system that installs faster and easier than comparable composite rail, with the fit and finish of traditional wood rail.

- Rated for 10ft residential & commercial level spans
- Rated for 8ft residential & commercial stair spans

✓ 1-1/4" Square-Edge, Solid Balusters

**PRICE RANGE:** [Icons: 1 gold, 1 silver, 1 bronze, 1 white]

**INSTALLATION:** [Icons: 1 wrench, 1 screwdriver, 1 hammer, 1 saw]



**RS35 DARTMOUTH EXTRUDED RAIL**  
Screw-together system with all the value of Hampton Rail, at a larger scale – perfect for commercial & large-scale residential projects.

- Rated for 12ft residential & commercial level spans
- Rated for 8ft residential & commercial stair spans

✓ 1-1/2" Square-Edge, Solid Balusters

**PRICE RANGE:** [Icons: 1 gold, 1 silver, 1 bronze, 1 white]

**INSTALLATION:** [Icons: 1 wrench, 1 screwdriver, 1 hammer, 1 saw]



**NAUTILUS CUSTOM MILLED RAIL**  
Custom milled railing, designed to your exact specifications. Renders custom wood rail obsolete.

- Rated for 10ft residential & commercial level spans
- Rated for 8ft residential & commercial stair spans

✓ 1-1/2" - 5" Solid Standard or Custom Balusters

**PRICE RANGE:** [Icons: 1 gold, 1 silver, 1 bronze, 1 white]

**INSTALLATION:** [Icons: 1 wrench, 1 screwdriver, 1 hammer, 1 saw]



## Section 01 RAILING SYSTEMS

# Common Features EXTRUDED RAIL

Nothing adds distinction and definition to homes and outdoor living spaces like a stylish exterior railing. Both beautiful and functional, a deck or exterior railing can be stunningly elegant, classically simple or designed as a wrap-around porch with real curb appeal. Cellular PVC railings are a great choice for your railing system.

### ALL EXTRUDED INTEX RAILS:

- Matte finish - 100% Cellular PVC with aluminum-reinforced core
- Hidden Stainless Steel fasteners
- Square-edge balusters and square-edge posts
- Compatible with 5" standard Newel Wrap with 6", 8", 10", and 12" available as upgrades
- Independent lab tested and certified with Code Compliance Research Report (CCRR)
- Low maintenance and easy to clean
- Multiple unique upgrades available for all INTEX Rail System to set your project apart!
- Do not require paint, but can be painted with a light reflective value (LRV) of 55 or greater



Background: Hampton Flat 10ft Span

## Common Upgrades for Extruded Kits



Radius Rail  
(Showing Liberty RS60275)



Aluminum-Reinforced Gates  
(Showing Hampton Flat)



Decorative Panels  
(Showing Dartmouth Peaked)



Glass Balusters  
(Showing Liberty RS60275)

Additional upgrades available for specific Extruded Rail Systems. Upgrades start on page 16.

# How to Order EXTRUDED RAIL KITS

### STEP 1

#### Select a Structural Post

- INTEX Structural Post Mount
  - Wood Mount Hardware
  - Concrete Mount Hardware
- Pressure Treated 4x4
- Pressure Treated 6x6

### STEP 2

#### Select a Newel Wrap Size & Style

- NEWEL5-EX  
*Fits 4 x 4 Or Structural Post Mount*
- NEWEL5  
*Fits 4 x 4 Or Structural Post Mount*
- NEWEL6.5  
*Fits 4 x 4, 6 x 6, Or Structural Post Mount*











### STEP 3

#### Select a Style & Size for Newel Cap + Base Trim

- Injection Molded Cap & Base**
- IMPC5
  - IMTR5
- Cellular PVC Caps & Bases**
- NCFLAT
  - NCPYRAMID
  - NCHAR5
  - NBTR
- For Upgraded Cap Styles See Page 36*

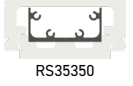

### STEP 4

#### Select a Rail Profile

- RS60 Liberty Rail
  -  RS60275
  -  RS60350
  -  Bottom Rail
- RS40 Hampton Rail
  -  RS40350P
  -  RS40350F
  -  Bottom Rail
- RS70 Providence Rail
  -  RS70
  -  Bottom Rail
- RS35 Dartmouth Rail
  -  RS35400
  -  RS35350
  -  Bottom Rail

### STEP 5

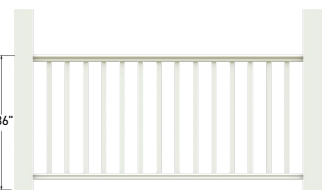
#### Select a Rail Height

- 36" Rail Height
  - 
- 42" Rail Height
  - 

### STEP 6

#### Select Desired Upgrades (If Any)

- Decorative Panels
- Radius Bend(s)
- Single Gates
- Double Gates
- Black, Round Aluminum Balusters\*
- Drink Rail
- 3-Line Rail\*
- FSC Mahogany Top Cap\*
- Glass Balusters
- Glass Panels\*
- Louver Infill\*
- Horizontal Balusters\*
- Lighted Newel Caps

*Rail Upgrades, \*Including Availability By Rail Line, Start on Page 16*

# Liberty RS60 EXTRUDED RAIL

## Unique Routed Rail System That Saves on Labor and Material Costs!



Liberty RS60275 Racking Stair & Level Sections with 5" Newel Wraps & Flat Panel Column Wraps

### UNIQUE LIBERTY RAIL FEATURES

- Pre-routed for easy installation - save on labor!
- Our 2 3/4" RS60275 profile is IRC Code R311.7.8.3 Compliant for residential stair graspability
- Standard kits ship with hollow 1 1/4" square-edge balusters, which reduce material costs (available for 6', 8', & 10' level & stair spans)
- New upgrade - Black, Round Aluminum Balusters!

### PATENTED RACKING STAIR SYSTEM

Pre-routed for easy assembly with an innovative Racking Stair detail that accommodates 18° to 40° Rake Angle.

### LONGER, CODE COMPLIANT SPANS

Meets International Residential Code (IRC) for spans up to 10 feet on both level and stair rail.

### POPULAR UPGRADES FOR LIBERTY:



Glass Balusters



Decorative Panels

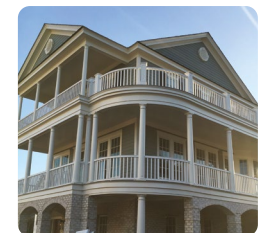

Radius Rail

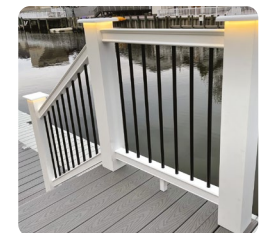

Black Balusters/Lighted Caps

Details For All Available Rail Upgrades Start On Page 16

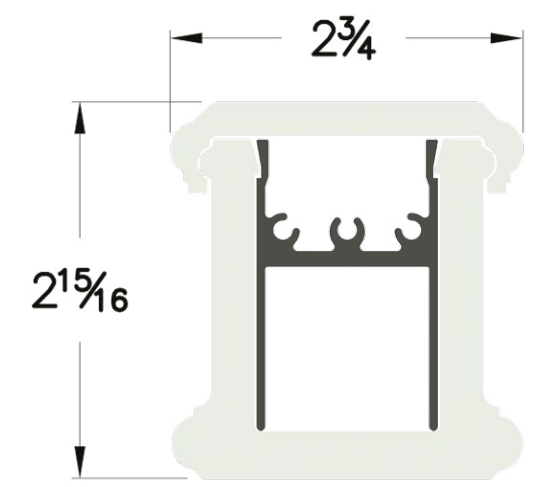

### LIBERTY RS60275 Graspable Flat Top

2-3/4" Liberty is our simple, beverage-friendly profile. This is a popular profile for both level and stair applications.

PRICE RANGE: \$ \$ \$ \$

INSTALLATION: ✂ ✂ ✂ ✂



RS60 Liberty Kits	6' Length	8' Length	10' Length	12' Length
36" Height	✓	✓	✓	✗
42" Height	✓	✓	✓	✗
Stair Application	✓	✓	✓	✗

GET AN INSTANT QUOTE!  
INTEXMILLWORK.COM

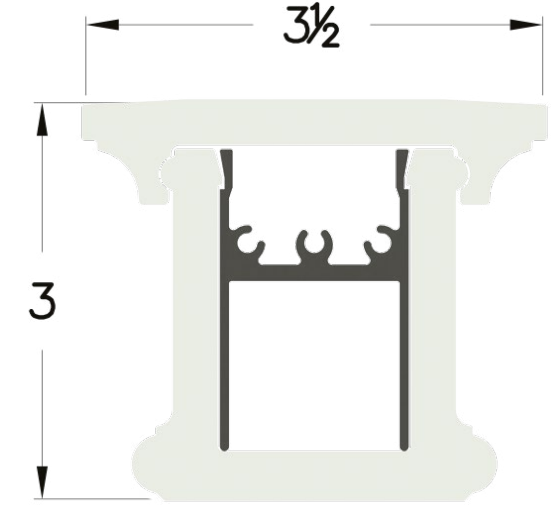

### LIBERTY RS60350 Flat Top with Character

3-1/2" Liberty is our decorative, beverage-friendly profile. This profile is predominantly used for level rail, in conjunction with 2-3/4" profile on stair applications.

PRICE RANGE: \$ \$ \$ \$

INSTALLATION: ✂ ✂ ✂ ✂



# Hampton RS40 EXTRUDED RAIL

## An Economical Rail Solution with Performance Superior to Composite Railing



Hampton Flat with Chamfered Newel & Column Wraps

### UNIQUE HAMPTON RAIL FEATURES

- Standard kits ship with solid 1 1/4" square-edge balusters
- FSC Certified Mahogany Cap upgrade available for both hampton profiles!



### RAIL ASSEMBLY JIG

Our reusable rail assembly jig is designed specifically to help reduce installation times and labor cost. The Assembly Jig makes it easier to align, center and space balusters.

### LONGER, CODE COMPLIANT SPANS

Meets commercial requirements of International Building Code (IBC) and International Residential Code (IRC) for level spans up to 10 feet and stair spans up to 8 feet.

### POPULAR UPGRADES FOR HAMPTON:

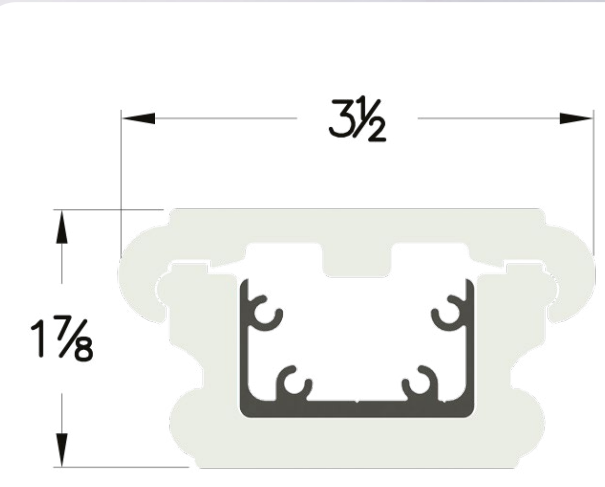
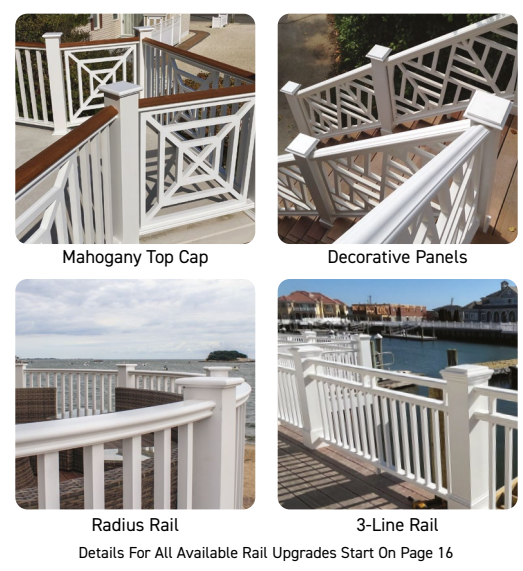

### HAMPTON RS40350F Beverage Friendly Top

Hampton Flat is our most popular profile in a beverage-friendly detail. This profile is available as our standard Cellular PVC flat profile or a Mahogany flat profile upgrade.

PRICE RANGE: \$ \$ \$ \$

Installation: ✂ ✂ ✂ ✂



RS40 Hampton Kits	6' Length	8' Length	10' Length	12' Length
36" Height	✓	✓	✓	✗
42" Height	✓	✓	✓	✗
Stair Application	✓	✓	✗	✗

GET AN INSTANT QUOTE! [INTEXMILLWORK.COM](http://intexmillwork.com)

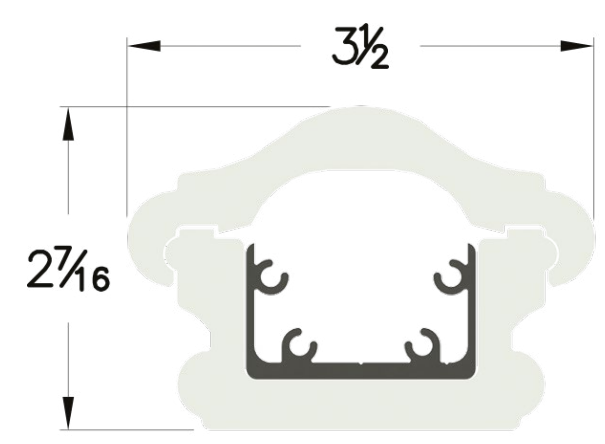

### HAMPTON RS40350P Traditional Rail Style

Our Peaked Hampton profile brings an added touch of historic detail with its rounded design. This profile is available as our standard Cellular PVC peaked profile or a Mahogany peaked profile upgrade.

PRICE RANGE: \$ \$ \$ \$

INSTALLATION: ✂ ✂ ✂ ✂



# Providence RS70 EXTRUDED RAIL

## Durability That Far Surpasses Wood and Other Traditional Materials!



Providence Level Section with Type 1 Deco Panel, Providence Stair Section with 5" Newel Wraps

### UNIQUE PROVIDENCE RAIL FEATURES

- Commercially code approved for 10' level spans
- Standard kits ship with solid 1 1/4" square-edge balusters

### LONGER, CODE COMPLIANT SPANS

Meets commercial requirements of International Building Code (IBC) and International Residential Code (IRC) for level spans up to 10 feet and stair spans up to 8 feet.

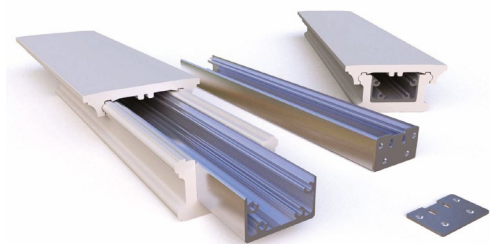

### POPULAR UPGRADES FOR PROVIDENCE:



Aluminum Reinforced Gates



Decorative Panels



Radius Rail

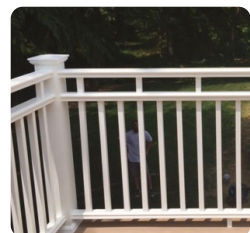

3-Line Rail

Details For All Available Rail Upgrades Start On Page 16

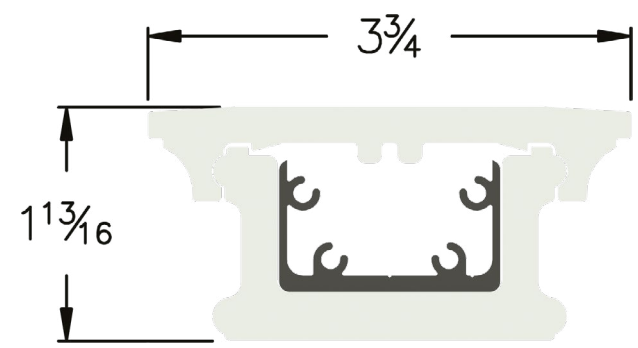

### PROVIDENCE RS70

## Extra-Wide Flat Top

A flat, beverage-friendly profile that's available in the New England area. Contact your INTEX Sales Representative for more information.

PRICE RANGE:

INSTALLATION:



RS70 Providence Kits	6' Length	8' Length	10' Length	12' Length
36" Height	✓	✓	✓	✗
42" Height	✓	✓	✓	✗
Stair Application	✓	✓	✗	✗



GET AN INSTANT QUOTE!  
INTEXMILLWORK.COM

# Dartmouth RS35 EXTRUDED RAIL

## A Classic and Elegant Rail Profile with Modern Characteristics



Dartmouth Flat with Recessed Panel Newel Wraps

### UNIQUE DARTMOUTH RAIL FEATURES

- Commercially code approved for 12' spans with heavy-duty aluminum
- Standard kits ship with solid 1 1/2" square-edge balusters

### RAIL ASSEMBLY JIG

Our reusable rail assembly jig is designed specifically to help reduce installation times and labor cost. The Assembly Jig makes it easier to align, center and space balusters.

### LONGER, CODE COMPLIANT SPANS

Meets commercial requirements of International Building Code (IBC) and International Residential Code (IRC) for level spans up to 12 feet and stair spans up to 8 feet.

### POPULAR UPGRADES FOR DARTMOUTH:



Louver Infill

Horizontal Balusters

Radius Rail

Glass Panels

Details For All Available Rail Upgrades Start On Page 16

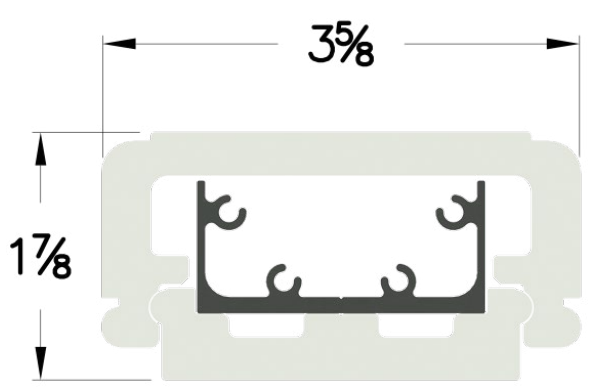

### DARTMOUTH RS35350 Reinforced Super Strength

Our Dartmouth Flat profile combines a beverage friendly rail with incredible strength, suitable for residential or commercial projects.

PRICE RANGE: \$ \$ \$ \$

INSTALLATION: ✂ ✂ ✂ ✂



RS35 Dartmouth Kits	6' Length	8' Length	10' Length	12' Length
36" Height	✓	✓	✓	✓
42" Height	✓	✓	✓	✓
Stair Application	✓	✓	✗	✗

 GET AN INSTANT QUOTE!  
INTEXMILLWORK.COM

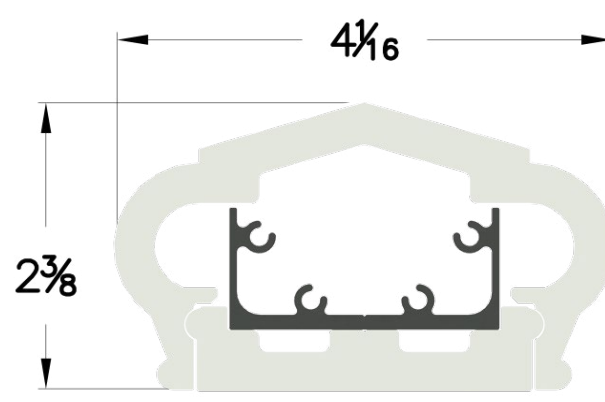

### DARTMOUTH RS35400 Our Most Robust Profile

Our Dartmouth Peaked profile was designed with traditional wood and historical charm in mind. Enjoy these characteristics without the rot or warp of wood!

PRICE RANGE: \$ \$ \$ \$

INSTALLATION: ✂ ✂ ✂ ✂



# Nautilus MILLED RAIL



## How to Order Nautilus Custom Milled Rail

Our premier railing system built by craftsmen just like a wood rail would have been made years ago. The components are milled, assembled, hand sanded and then primed, so they are ready for the finish coat of your choice.

- 5", 6", 7" and 8" standard rail widths
- Custom profiles available
- Spans up to 10' for IBC level application
- Spans up to 8' for IBC stair application
- Gooseneck available for RS50500
- Square, Chamfered, or Turned Balusters available in multiple sizes
- Painting required; paint must be light reflective value (LRV) of 55 or greater

### STEP 1

#### Select a Structural Post

- INTEX Structural Post Mount
  - Wood Mount Hardware
  - Concrete Mount Hardware
- Pressure Treated 4x4
- Pressure Treated 6x6

### STEP 2

#### Select a Newel Post Wrap Size & Style

- NEWEL6.5  
*Fits 5" Rail or Smaller*
- Millwork Newels  
*Newel Width Should Be At Least 1" Larger Than Rail Width. See page 33 for Millwork Newel Sizes and Styles*

### STEP 3

#### Select a Newel Cap Style

- Non-Skirted Newel Cap  
*Fits all flush and directional paneled newels*
- Skirted Newel Cap  
*Fits all flush and panel 4-side newels*

### STEP 4

#### Select a Rail Profile

- Nautilus RS10500
- Nautilus RS50500
- Nautilus RS10600
- Nautilus RS20700
- Nautilus RS20800

### STEP 5

#### Select an Infill

- Square Baluster (A)
- Chamfered Baluster (B)
- T1 Turned Baluster (C)
- T2 Turned Baluster (D)
- Square Decorative Panel
- Full Decorative Panel

### STEP 6

#### Select Desired Gate(s) and or Upgrades (If Any)

- Single Gate
- Double Gate
- Deco Panels
- Radius Rail
- Glass Balusters

**NAUTILUS BALUSTERS**  
Standard Nautilus Balusters (shown, right) are available as 1.5", 2", 2.5", 3.5" or 5" widths. Custom balusters are available at all widths and heights.

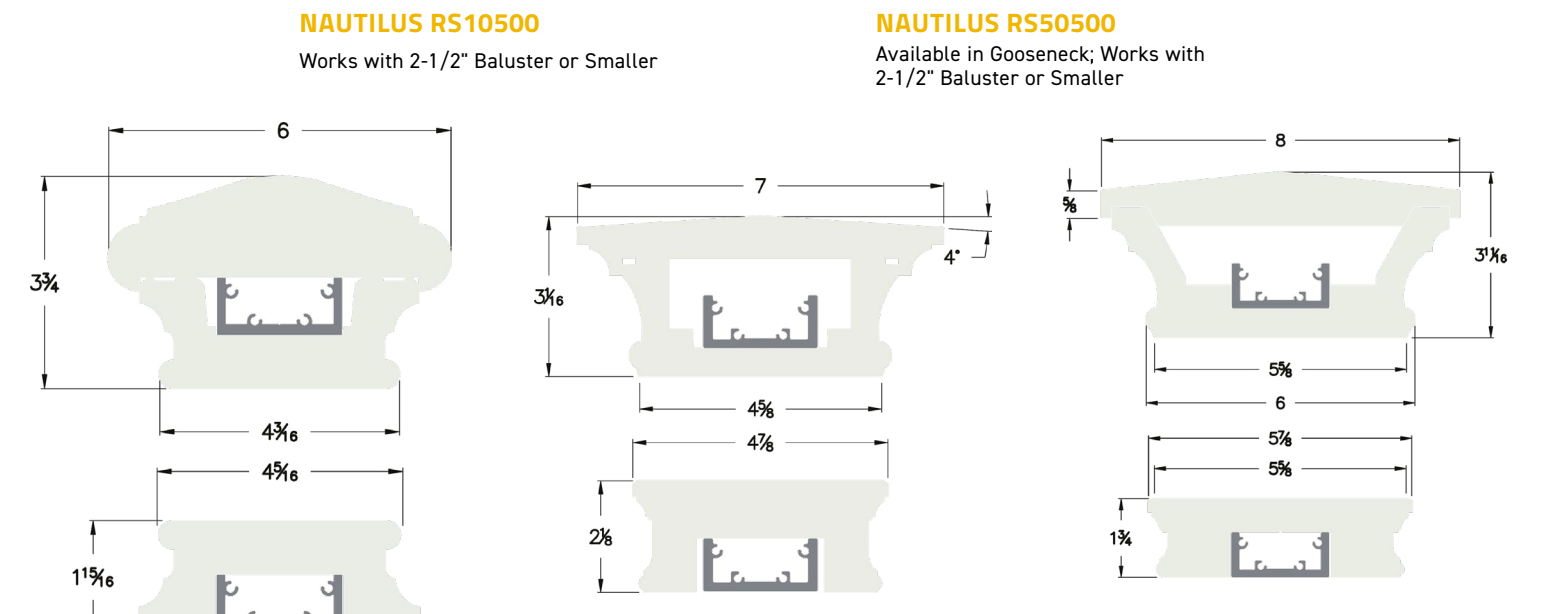
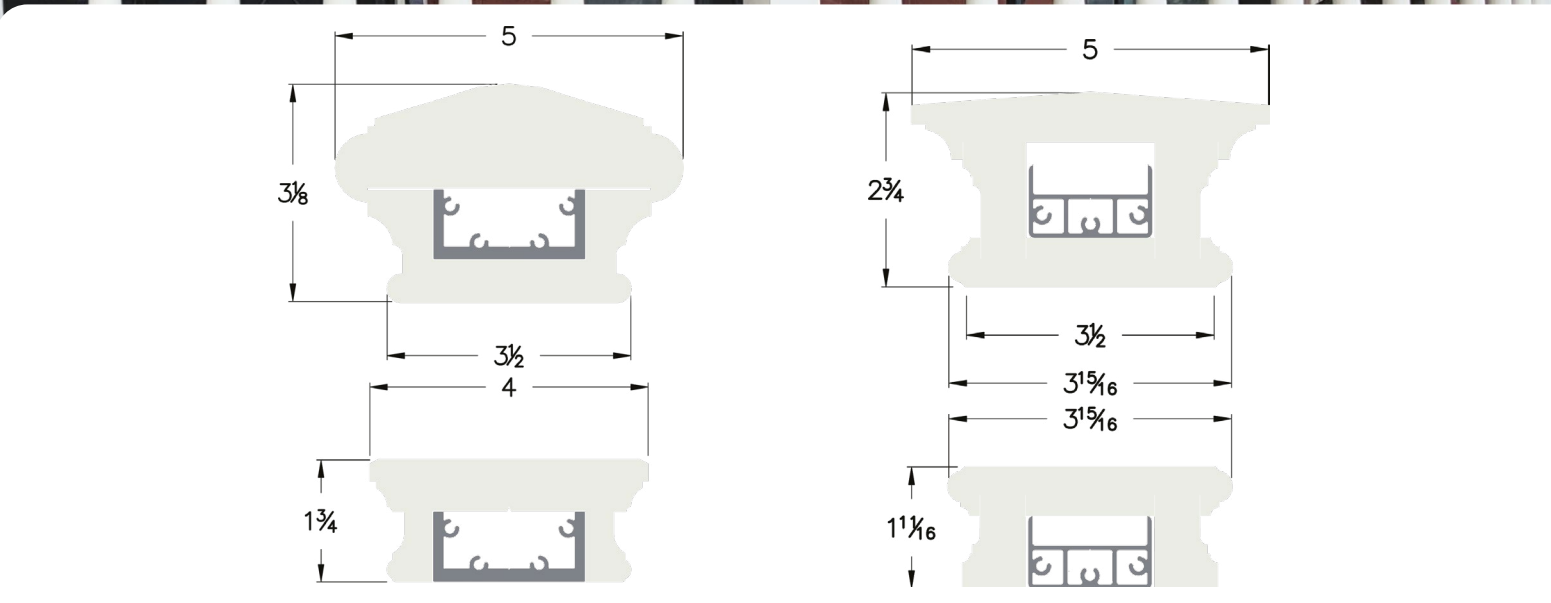
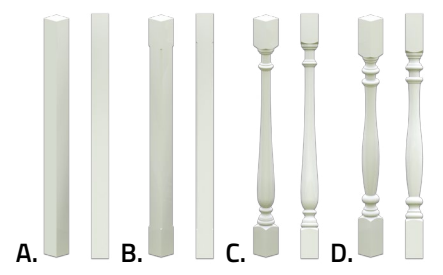

**GET AN INSTANT QUOTE!**  
INTEXMILLWORK.COM

All Nautilus Rail	6' Length	8' Length	10' Length	12' Length
36" Height	✓	✓	✓	✗
42" Height	✓	✓	✓	✗
Stair Application	✓	✓	✗	✗



# Deco Panels RAIL UPGRADES

Decorative Panel Common Features
All Deco Panel styles are available for all rail systems
All Deco Panel styles are available for level, stair & radius rails
All Deco Panel styles are available as 36" or 42" heights
Deco Panels for Liberty, Hampton, Providence & Dartmouth come pre-finished and do not require paint, but can be painted with a light reflective value (LRV) of 55 or greater. Nautilus Deco Panels require paint.



Hampton Flat with Type 2 Deco Panels & 5" Newel Wraps

## Square Decorative Panel Standard Styles

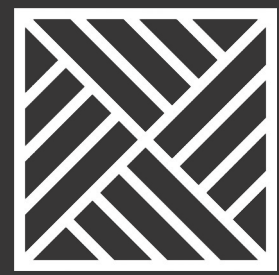

TYPE 2



AVALON

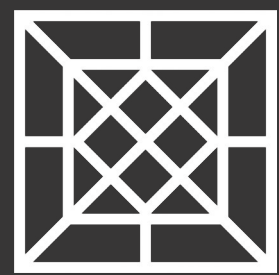

DIAMOND WEB

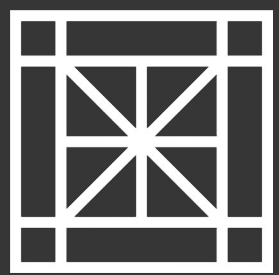

PRAIRIE

Visit [intexmillwork.com](http://intexmillwork.com) for more Standard Square Deco Panel Styles

# Deco Panels RAIL UPGRADES

The following page contains examples of fully-built rail sections featuring various Standard Deco Panels, Newel Wraps, Newel Caps, and Trim Rings. Please note all Deco Panels, Newel Wraps, Newel Caps, and Trim Rings are sold separately from Rail Kits.



Nautilus RS20500 Custom Rail with Modified Double Diamond Web Deco Panels

## Double Decorative Panel Standard Styles

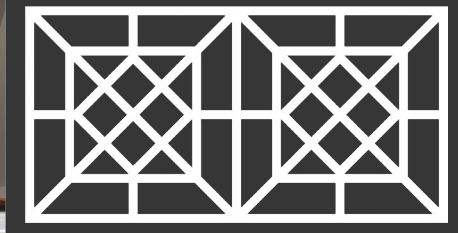

DOUBLE DIAMOND WEB

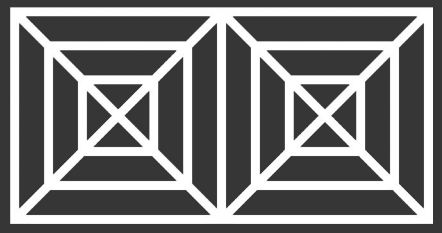

DOUBLE SQUARE WEB

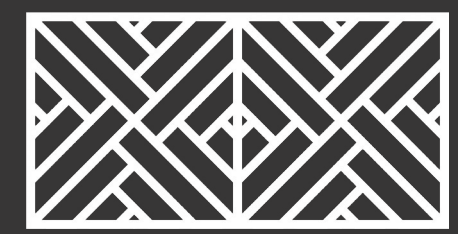

DOUBLE TYPE 1

Visit [intexmillwork.com](http://intexmillwork.com) for more Standard Double Deco Panel Styles

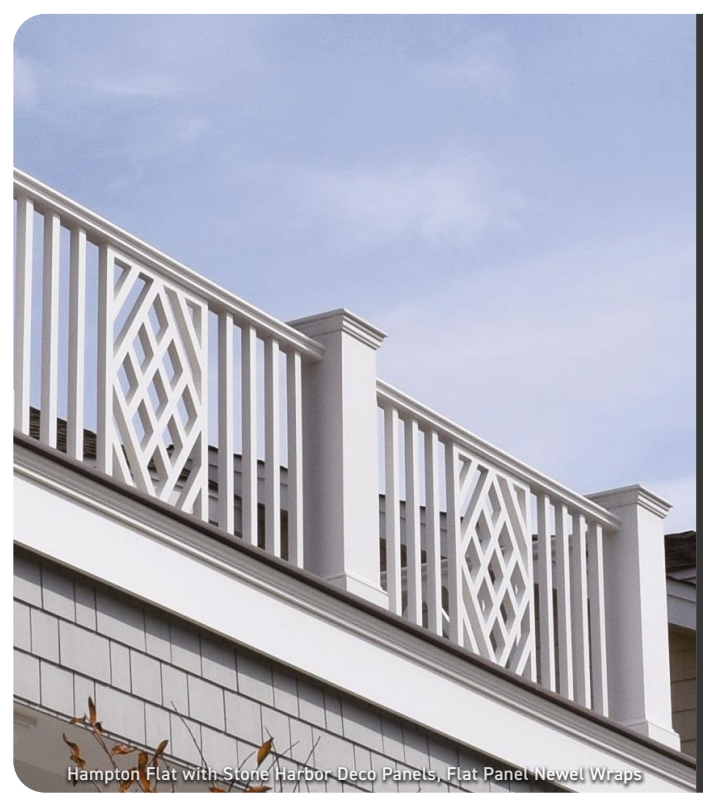

Hampton Flat with Stone Harbor Deco Panels, Flat Panel Newel Wraps

## Narrow Decorative Panel Standard Styles

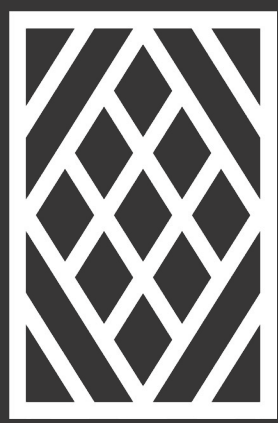

STONE HARBOR



VENTNOR



WILDWOOD

Visit [intexmillwork.com](http://intexmillwork.com) for more Standard Narrow Deco Panel Styles



Dartmouth Peaked with Modified 7 Mile Island Full Infill Deco Panels, Flat Panel Newel & Column Wraps

## Full Infill Decorative Panel Standard Styles

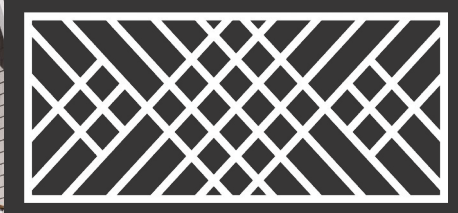

7 MILE ISLAND



REFLECTING



TYPE 3L

Visit [intexmillwork.com](http://intexmillwork.com) for more Standard Full Infill Deco Panel Styles

### SQUARE DECO PANELS



AVALON

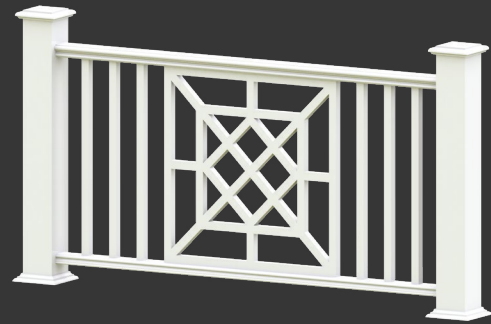

DIAMOND WEB

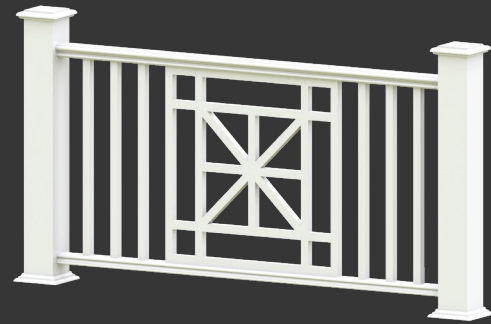

PRAIRIE

### NARROW DECO PANELS



STONE HARBOR

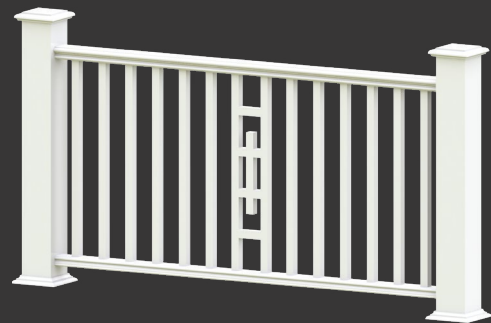

VENTNOR

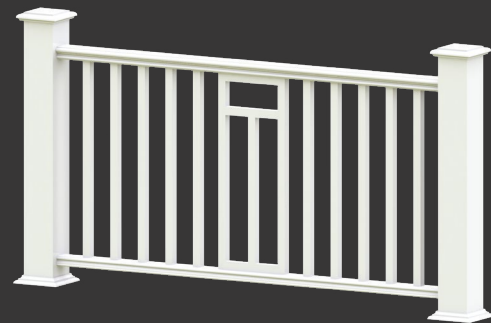

WILDWOOD

### DOUBLE DECO PANELS

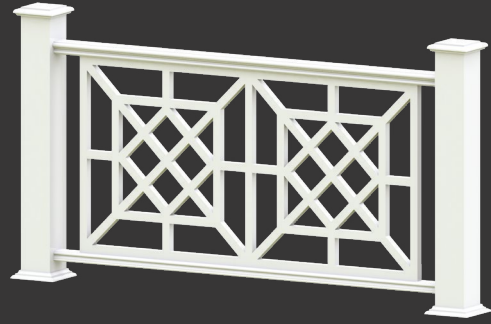

DOUBLE DIAMOND WEB

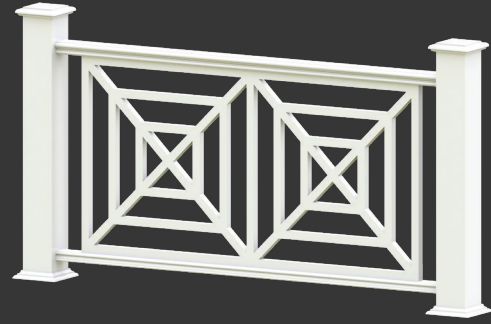

DOUBLE SQUARE WEB

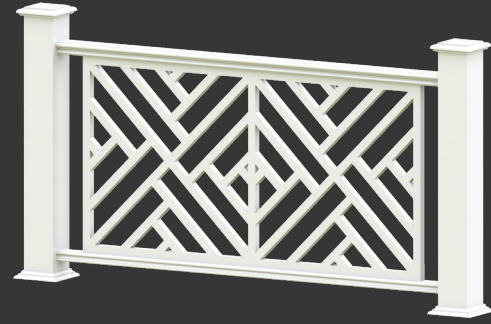

DOUBLE TYPE 1

### FULL INFILL DECO PANELS

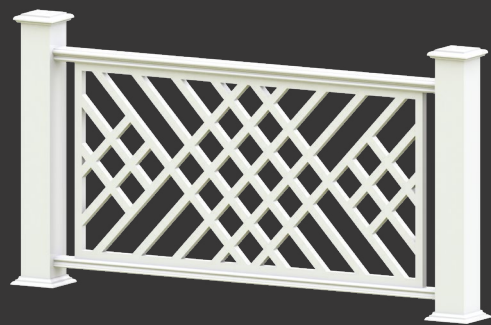

7 MILE ISLAND

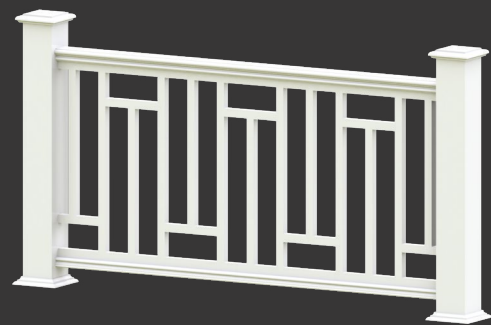

REFLECTING



TYPE 3L

All full section renders are shown with Hampton Flat and 5" Newel Wraps with NCPYRAMID Cap and NBTR Trim Ring

# Custom Decorative Panels RAIL UPGRADES

Take Your Railing Project to the Next Level with Fully Customized Decorative Panels!

#### CUSTOM DECORATIVE PANELS

- Choose from our library of custom panels, or create your own
- Available as a Square, Narrow, Double or Full Infill panel in your custom design
- Available for level, stair and radius rail applications
- Compatible with all INTEX Rail Systems
- Custom Deco Panels for Liberty, Hampton, Providence, & Dartmouth come pre-finished and do not require paint, but can be painted with a light reflective value (LRV) of 55 or greater. Nautilus Deco Panels require paint.



Scan to see our library of Custom Deco Panel examples!

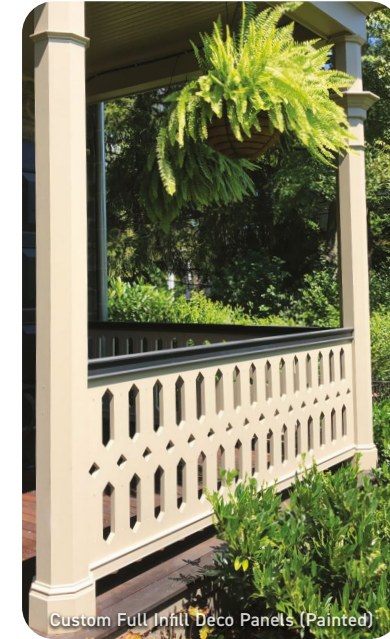

Custom Full Infill Deco Panels (Painted)

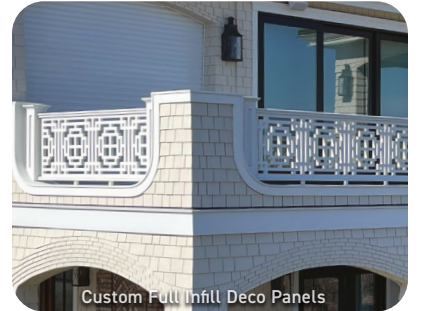

Custom Full Infill Deco Panels



Custom Full Infill Deco Panels

#### FROM CONCEPT TO REALITY!

INTEX's Custom Deco Panel capabilities allow you to customize your rail infill design at an affordable price-point in a short lead-time. Pricing for Custom Deco Panels is simply based on thickness, width, and height, so the design flexibility is limitless!

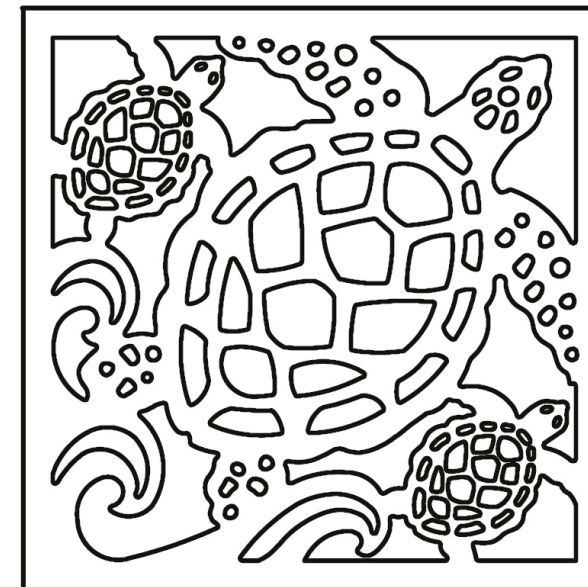

Custom Square Deco Panels

# Radius Rail RAIL UPGRADES

**Guaranteed Custom Radius Fit with Our Radius Rail Template Kit!**



Nautilus 20500 3-Line Rail with Radius Bends, Chamfered 2" Balusters, Recessed Panel Newel Wraps

**CUSTOM IN-HOUSE RADIUS BENDS**

We are proud to offer in-house Radius Rail arcs from 6ft, 8ft, and 10ft rail spans. For stairway applications 6ft and 8ft spans are available

**THE INTEX GUARANTEE**

We guarantee the Radius Rail fit when the INTEX Radius Rail Template Kit is used. Call 856-293-4100 to order a Radius Rail Template Kit!

**RADIUS RAIL AVAILABILITY**

	Level Rail			Stair Rail	
	6'	8'	10'	6'	8'
<b>Liberty</b>	✓	✓	✓	✓	✓
<b>Hampton</b>	✓	✓	✓	✓	✓
<b>Providence</b>	✓	✓	✓	✓	✓
<b>Dartmouth</b>	✓	✓	✓	✓	✓
<b>Nautilus</b>	✓	✓	✓	✗	✗



**SCAN FOR VIDEO GALLERY!**  
Then scroll to the "Rail Templating" section for Radius Rail tutorials!

# Gates RAIL UPGRADES

Gates for INTEX Rail Systems are reinforced with welded aluminum frames, crafted with no open cells and are available using any of our standard rail profiles. Available as single or double gates. INTEX Gates cannot be trimmed or cut to size.



**Liberty Gates**



**Hampton Gates  
Providence Gates**



**Dartmouth Gates**



**Nautilus Custom Gates**



Hampton Flat with Double Gate & 5" Newel Wraps

**GATE HARDWARE**

INTEX Rail Gate Mounting Hardware set includes Two 12" Band Hinges, Latch & Stop, all in black.

- A. Face-Mount Hardware Application**
- B. In-Line Hardware Application**

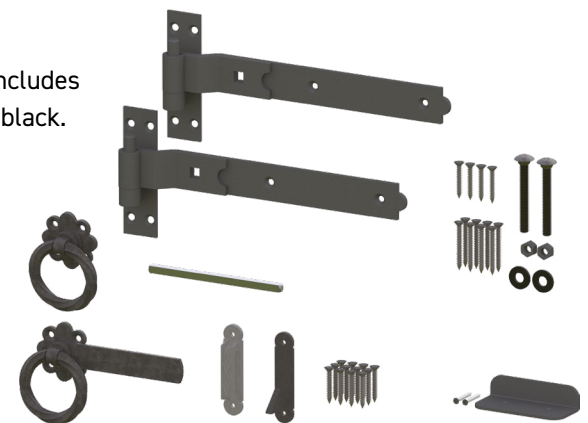

# Black Balusters RAIL UPGRADES



## Enjoy a Clean, Modern Look with Black, Round Aluminum Balusters for Liberty Rail!



Liberty RS60350 with Black Baluster Infill, Custom Double Gate, 5" Newel Wraps & Recessed Panel Column Wraps

### FULL KITS FOR LIBERTY RAIL

- Modern infill with minimal visual obstruction
- Pre-routed for easy installation - save time and money on labor!
- Kits compatible with both Liberty profiles
- Our 2 3/4" (RS60275) flat top profile is IRC Code R311.7.8.3 compliant for residential stair graspability
- Innovative Racking Stair detail that accommodates 18° to 40° Rake Angle
- Available as 6' or 8' kits at 36" and 42" heights for level or stair applications

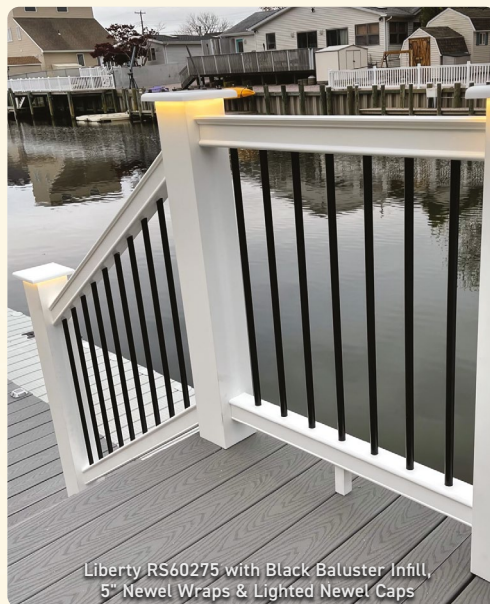

Liberty RS60275 with Black Baluster Infill, 5" Newel Wraps & Lighted Newel Caps

# Drink Rail RAIL UPGRADES

"Post-To-Post" Drink Rail Design with NEWEL6.5, NCFLAT6.5, NBTR6.5, and Liberty RS60275 Black, Round Aluminum Baluster Infill Kit. Best practice is for the Newel Wrap to be larger than the deck board.



"Over-The-Post" Drink Rail Design with NEWEL5, NBTR5 and Hampton Flat RS40350F Kit. Best practice is for the Newel Wrap to be smaller than the deck board.



### MATCH OR ACCENT YOUR INTEX RAILING TO YOUR DECK OR PORCH WITH DRINK RAIL!

- No special-order hardware necessary!
- Works in conjunction with INTEX Flat Top rail profiles (see chart)
- Compatible with hardwoods, softwoods, composite, and PVC decking
- Works as an "over the post" or "post to post" design
- Deck board and fasteners supplied by others
- Give your guests a spacious surface on which to set their drinks!

	Drink Rail Availability
Liberty RS60275	✓
Liberty RS60350	✓
Hampton RS40350F	✓
Hampton RS40350P	✗
Providence RS70	✓
Dartmouth RS35350	✓
Dartmouth RS35400	✗
Nautilus	✗

# 3-Line & Mahogany Rail RAIL UPGRADES



Nautilus 20500 3-Line Rail with Radius Bends, Chamfered 2" Balusters, Recessed Panel Newel Wraps

## Add an Extra Touch of Style and Character to Your Next Rail Project!

### 3-LINE RAIL KITS

3 Line Rail Kits include: Horizontal Rails, Structural Reinforcements, Square Balusters, Hardware and Crush Blocks.

	3-Line Rail Availability	FSC Mahogany Top Cap
Liberty	✗	✗
Hampton	✓	✓
Providence	✓	✗
Dartmouth	✓	✗
Nautilus	✓	✗

### FSC CERTIFIED MAHOGANY RAIL CAPS

Adding the timeless detail of a FSC Certified Mahogany Cap will bring your railing project to the next level with the look and feel of real wood! FSC Certified Mahogany Cap Upgrades come ready for the finish of your choice, and are available in level rail, stair rail and radius applications for Hampton Rail (Flat or Peaked).



Dartmouth Peaked 3-Line Rail with Radius Bends and 5" Newel Wraps



Hampton 3-Line Rail with FSC Mahogany Top Cap



Hampton Flat FSC Mahogany Top Cap with Square Web Deco & 5" Newel Wraps

# Glass Infills RAIL UPGRADES



GET AN INSTANT QUOTE!  
INTEXMILLWORK.COM

Whether it's your waterfront destination, or your countryside escape – INTEX railing with glass balusters combine the beauty and sight lines of an unobstructed view, with the safety of traditional, vertical rail infill.

### GLASS BALUSTERS

- Available in 6ft & 8ft lengths at 36" or 42" height, for level rail applications only
- Liberty top & bottom rails are pre-routed for a clean look with easy installation with no mechanical fastening or field routing
- Tempered Glass Balusters (1/4" x 3-5/8") come in packs of 5
- Enjoy a beautiful, unobstructed view that lets in a cool breeze!
- Hampton, Providence, Dartmouth, and Nautilus top and bottom rails are prepped for glass with a pre-applied routed channel



Liberty RS60350 with Glass Balusters & 5" Newel Wraps

	Glass Baluster Availability
Liberty	✓
Hampton	✓
Providence	✓
Dartmouth	✓
Nautilus	✓

### GLASS PANELS

- Enjoy a beautiful, unobstructed view!
- Available in 6ft & 8ft lengths for level and stair applications
- Glass Panel Rail Sets are designed to be used with 3/8" thick tempered glass panels, supplied by others
- Glass Panel Rail Sets include heavy-duty aluminum reinforcements, clamps and associated hardware to mount 3/8" tempered glass panel (by others)
- Specs for 3rd party glass are available through your INTEX Millwork Sales Rep



Dartmouth Peaked with Glass Panels and 5" Newel Wraps

	Glass Panel Availability
Liberty	✗
Hampton	✗
Providence	✗
Dartmouth	✓
Nautilus	✗

# Louver Infill RAIL UPGRADES

INTEX Louver Infill is fast and easy to install, and available in pre-assembled panelized systems (i.e. triangular or round gable louver vents), or in knocked down systems to be trimmed and custom fit in the field (i.e. louver shower walls, privacy dividers, and rail infill). The perfect way to create privacy while maintaining airflow!

## LOUVER RAIL INFILL

- Greater privacy while maintaining airflow to your deck
- Perfect solution to hiding visible air conditioner units and mechanicals while maintaining airflow
- Ships as knocked down, trimmable system at 6', 8', and 10' level sections only, for 36" or 42" high rail
- Custom heights also available
- Stair rail application does not come pre-routed, requires technical installation

	Louver Rail Infill Availability
Liberty	✗
Providence	✓
Hampton	✓
Dartmouth	✓
Nautilus	✗



## Louver Accessories

### LOUVER GABLE VENTS

- Available as functional or decorative
- Available in custom sizes
- Available pre-assembled or knocked down system
- Custom shapes available include triangle, square, round, circle-top, etc.



### LOUVER PRIVACY WALLS

- Greater privacy while maintaining airflow
- Ships as knocked down, trimmable system made to your desired width and height
- Ideal for built-in outdoor showers, multi-family partitions for privacy, mechanical enclosures



Background Image: Dartmouth Flat with Custom Louver Infill

# Horizontal Baluster Infill RAIL UPGRADES



## HORIZONTAL BALUSTER INFILL

- Achieve a more contemporary or modern design without the cost, labor, or maintenance of alternative horizontal infills
- Ships as trimmable kits at 6', 8', and 10' level sections only, for 36" or 42" high rail
- Fast & easy installation due to pre-routed, vertical stanchions and easily trimmable sizes that create custom fits
- Custom heights also available
- Stair rail application does not come pre-routed, requires technical installation

	Horizontal Balusters Availability
Liberty	✗
Hampton	✓
Providence	✓
Dartmouth	✓
Nautilus	✗



# Transition Hardware RAIL UPGRADES

 **GET AN INSTANT QUOTE!**  
INTEXMILLWORK.COM

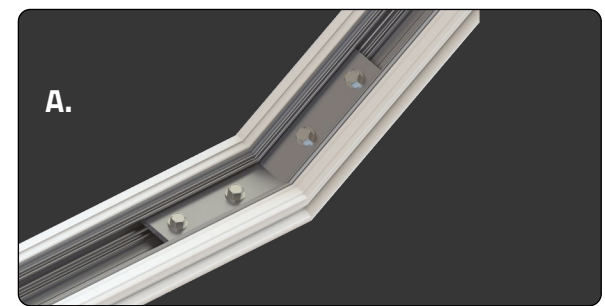

Rail Transition Hardware allows for mid-span change of direction in ways only previously achievable in wooden railing. When every detail matter, use Rail Transition Hardware to create the perfect installation!

**A. IN-LINE RAIL ELEVATION CHANGE, ADJUSTABLE (NOT AT A NEWEL)**

Adjustable by bending to the required angle, and will change the rail direction up or down.

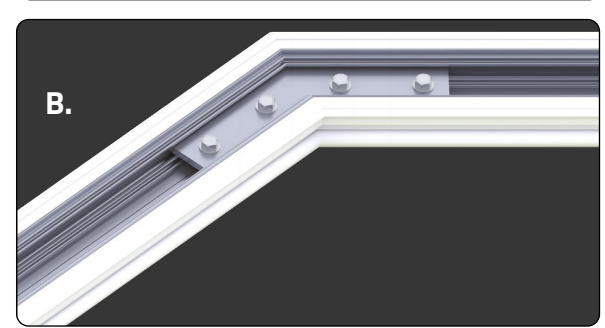

**B. LEVEL RAIL DIRECTION CHANGE 45° OR 90° (NOT AT A NEWEL)**

Used to change rail direction within the span, while leaving the connections to the newel(s) flush.

	Liberty	Hampton	Providence	Dartmouth	Nautilus
Transition Hardware	✓	✓	✓	✓	✓



**EXTRUDED 5" NEWELS**  
Our most common Newel Post, extruded as one piece and provides all the value of Cellular PVC at our lowest price point. Pairs with our most affordable cap and base trim.

PRICE RANGE:  INSTALLATION: 



**FABRICATED 5" & 6.5" NEWELS**  
Our mid-range Newel offering provides a hand-built newel with even sharper corners and a more traditional feel.

PRICE RANGE:  INSTALLATION: 



**MILLWORK NEWELS**  
When only the finest will do, our Millwork Newels provide a variety of sizes and panel options for the greatest of curb appeal.

PRICE RANGE:  INSTALLATION: 



**CUSTOM NEWELS**  
When a standard dimension post just won't do, we can design a post to your exact specification.

PRICE RANGE:  INSTALLATION: 

# Common Features NEWEL & COLUMN WRAPS

Wrapped in stylish designs, newels and columns can do double duty as both vital architectural components and dramatic visual elements. Homes adorned with columns and newels convey a feeling of timeless strength and beauty.

### ALL INTEX NEWEL & COLUMN WRAPS:

- 100% Cellular PVC
- Multiple panel styles available – see page 35
- Used with existing structural members or used in stand-alone non-structural applications
- Split Pedestal options available
- Compatible with all INTEX Rail Systems
- Custom Newel and Column Wraps can be created to meet your design requirements or for historic restoration!
- Do not require paint, but can be painted with a light reflective value (LRV) of 55 or greater

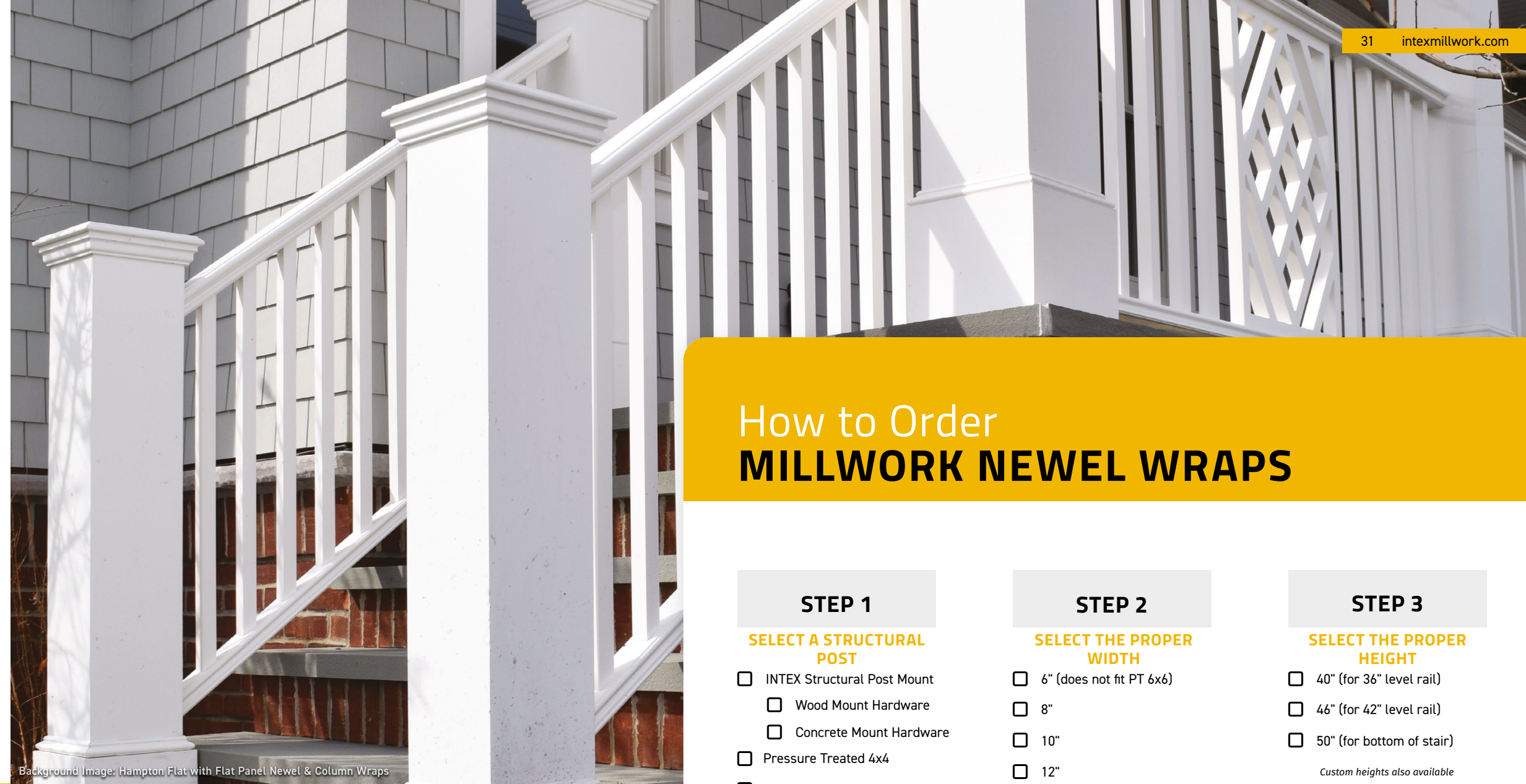

Background Image: Hampton Flat with Flat Panel Newel & Column Wraps

## How to Order MILLWORK NEWEL WRAPS

### STEP 1

#### SELECT A STRUCTURAL POST

- INTEX Structural Post Mount
  - Wood Mount Hardware
  - Concrete Mount Hardware
- Pressure Treated 4x4
- Pressure Treated 6x6

### STEP 2

#### SELECT THE PROPER WIDTH

- 6" (does not fit PT 6x6)
- 8"
- 10"
- 12"

Custom sizes also available

### STEP 3

#### SELECT THE PROPER HEIGHT

- 40" (for 36" level rail)
- 46" (for 42" level rail)
- 50" (for bottom of stair)

Custom heights also available

### STEP 4

#### SELECT A PANEL DETAIL

- Flush
- Recessed
- Recessed with Inlay
- Raised
- Chamfered

See page 35 for Panel Styles

### STEP 5

#### SELECT THE PANEL ORIENTATIONS

- Panel 4 Side
- Line
- Corner
- End

Refer to drawings on previous page for more information

### STEP 6

#### SELECT THE CAP STYLE & SIZE

- Skirted Caps (For Panel 4 Side)**
  - NTC-S40  
2 Tier Flat Cap with Skirt
  - NPTC-S40  
Pyramid Cap with Skirt
- Non-Skirted Caps (For Line Corner End)**
  - NTC  
2 Tier Flat Cap
  - NPTC  
Pyramid Cap

See page 36 for Newel Cap Styles

### Short Panel 4-Sides vs Line, Corner, and End Newels

- Short Panel 4-Side Newels are predominantly designed for Skirted Newel Caps (top rail dies into skirt, not newel face)
- Short Panel 4-Side can be used when the supplier doesn't know newel locations, but it is not recommended (inferior detail)
- Skirted Newel Caps cannot be used with Line, Corner, and End Newels
- Line, Corner, and End Newels are designed to give a full panel detail on non-rail side and flush panel face on rail side

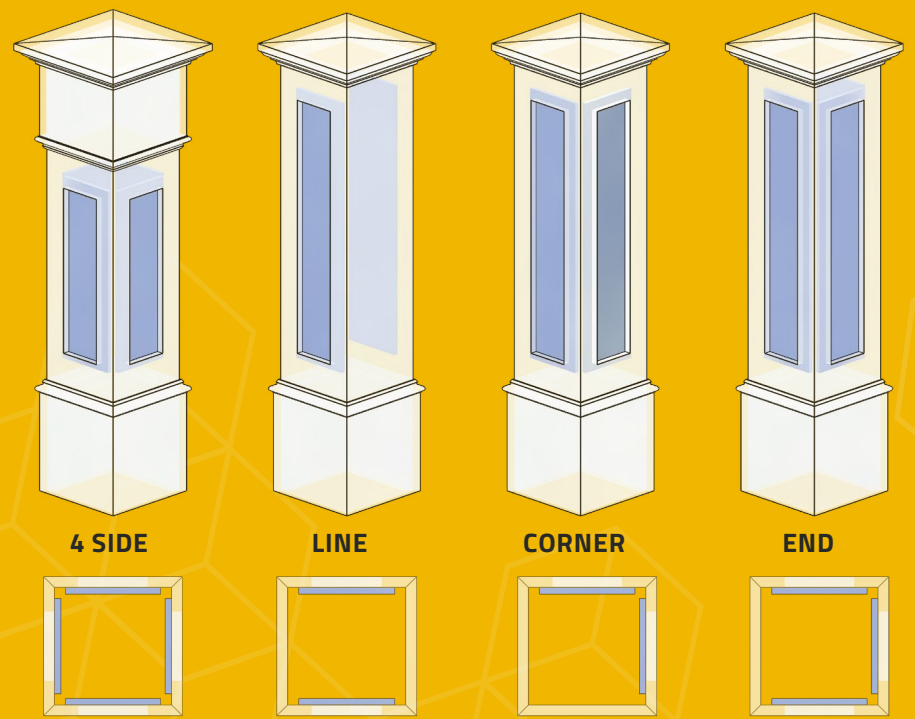



# Structural Posts NEWEL WRAPS



# Fabricated & Extruded NEWEL WRAPS



### POST-MOUNT & HARDWARE

- Structural Post System requires 2 items to complete; NEWELPOST36/42 (Structural Post) along with one of the following:
  - NEWELMOUNT-W (through bolt detail) **OR**
  - NEWELMOUNT-C (lag bolt detail)
- Includes #10 x 1-1/2" Rail Attachment Screws for proper fastening of rail to post
- Works for 36" & 42" level rail heights, and 36" stair rail heights
- Includes Injection Molded Compression Shims for easy use with NEWEL5 & NEWEL5-EX
- Salt Spray tested for coastal application

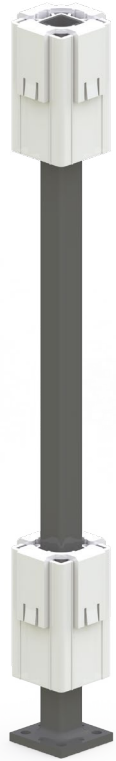

**NEWELPOST36/42**  
POST MOUNT WITH GUIDES

	Liberty	Hampton	Providence	Dartmouth	Nautilus
<b>Structural Posts</b>	✓	✓	✓	✓	✓

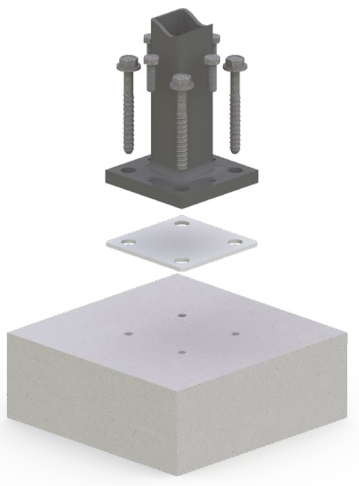

**NEWELMOUNT-C**  
POST MOUNT HARDWARE KIT FOR CONCRETE APPLICATION

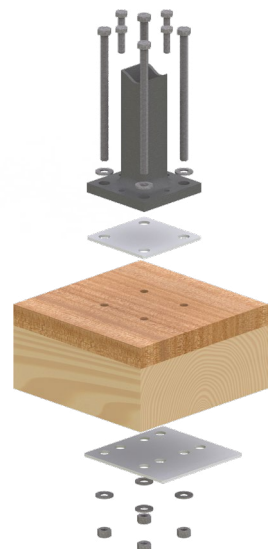

**NEWELMOUNT-W**  
POST MOUNT HARDWARE KIT FOR WOOD APPLICATION



**IMPC5** works with NEWEL5-EX & NEWEL5



**NCFLAT5** works with NEWEL5-EX & NEWEL5

**NCFLAT6.5** works with NEWEL6.5



**NCPYRAMID5** works with NEWEL5-EX & NEWEL5

**NCPYRAMID6.5** works with NEWEL6.5



**NCHAR5** works with NEWEL5-EX & NEWEL5

**NCHAR6.5** works with NEWEL6.5



**NEWEL SHAFT ONLY**



**NEWEL5-EX WITH IMPC5 & IMTR5**

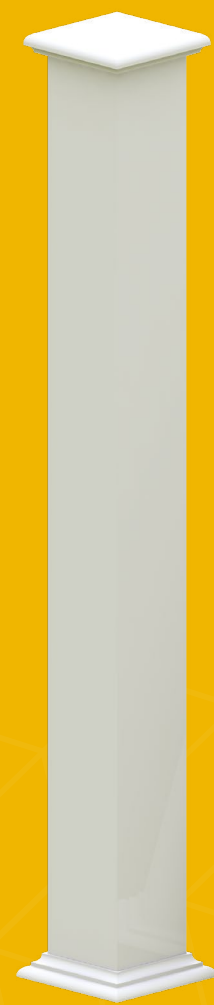

**NEWEL5 WITH NCFLAT5 & NBTR5**



**NEWEL6.5 WITH NCPYRAMID6.5 & NBTR6.5**

**NOTE:** Newel Wraps, Caps and Trim Rings are sold separately. These renders depict common Cap & Trim Ring scenarios/compatibility for Fabricated & Extruded Newel Wraps.

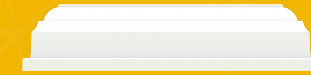

**IMTR5** works with NEWEL5-EX & NEWEL5



**NBTR5-EX** works with NEWEL5-EX  
**NBTR5** works with NEWEL5  
**NBTR6.5** works with NEWEL6.5

# Lighted Newel Caps NEWEL WRAPS

## EASY TO INSTALL SYSTEM

- Available for 5" Newel Wraps only
- Available as Flat Cap or Pyramid Cap
- System includes necessary "do it yourself" items to light each post:
  - One transformer style & size (150 Watt; can support up to 40 newels)
  - Timer & "Dusk to Dawn Photo Eye" sold separately

## ENERGY EFFICIENT LIGHTING

- Down-lit system with LED recessed under the Newel Cap gives a clean look
- 80% energy efficient vs. traditional Newel Cap lighting systems
- Low voltage DC system means no permits or electrician required to install



Liberty RS60275 with Lighted Newel Caps & 5" Newel Wraps



Liberty RS60275 with Lighted Newel Caps & 5" Newel Wraps

Lighted Newel Cap Availability	
Liberty	✓
Hampton	✓
Providence	✓
Dartmouth	✓
Nautilus	✗

 **GET AN INSTANT QUOTE!**  
INTEXMILLWORK.COM

Background Image: Liberty RS60275 with Lighted Newel Caps & 5" Newel Wraps

# Panel Styles MILLWORK NEWEL WRAPS

Millwork Newel Wraps are shipped fully assembled and ready to be incorporated with structural components – typically a 4 x 4, 6 x 6, or a Structural Post Mount – for installation.

## BEFORE ORDERING, PLEASE NOTE:

- 40" Newel Wraps are for use with 36" level rails
- 46" Newel Wraps are for use with 42" level rails
- 50" Newel Wraps are for use at the bottom of stairs

## INSIDE CLEARANCE

Newel Size	3/8" Flat	5/8" Raised, or Chamfered	Recessed or Recessed with Inlay
6"	5-1/4"	4-3/4"	4" at Center, 4-3/4" at Top & Bottom
8"	7-1/4"	6-3/4"	6" at Center, 6-3/4" at Top & Bottom
10"	9-1/4"	8-3/4"	8" at Center, 8-3/4" at Top & Bottom
12"	11-1/4"	10-3/4"	10" at Center, 10-3/4" at Top & Bottom

ACTUAL FOOTPRINT INCLUDES BASE WRAP

## FLAT PANEL

Available in 3/8" or 5/8" Wall

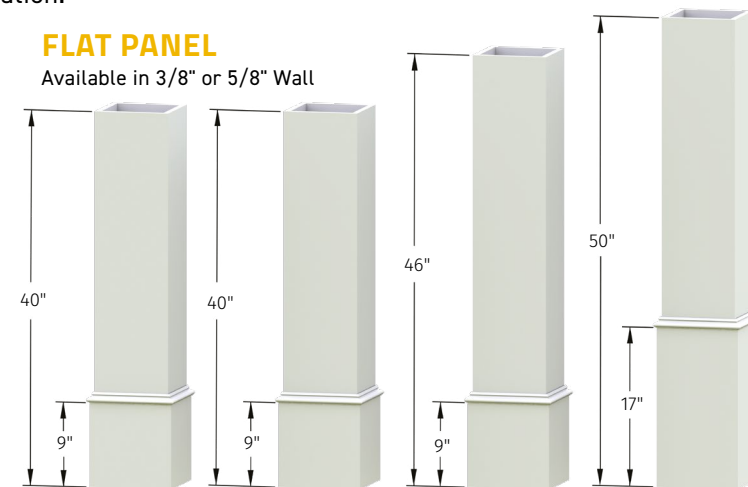

## RECESSED PANEL

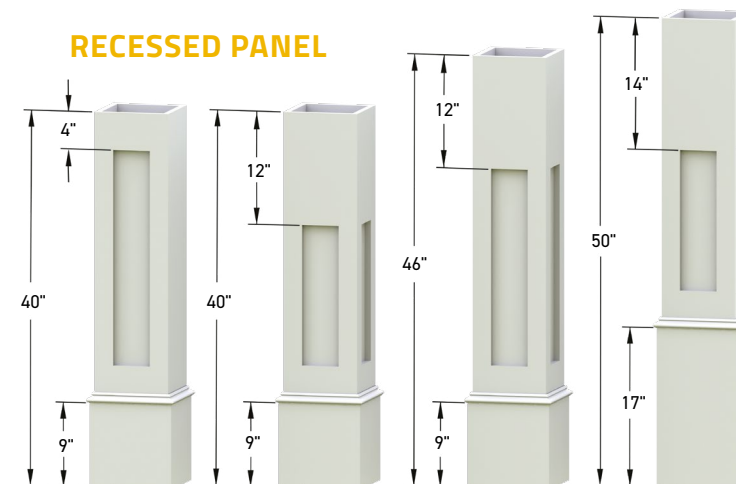

## CHAMFERED PANEL

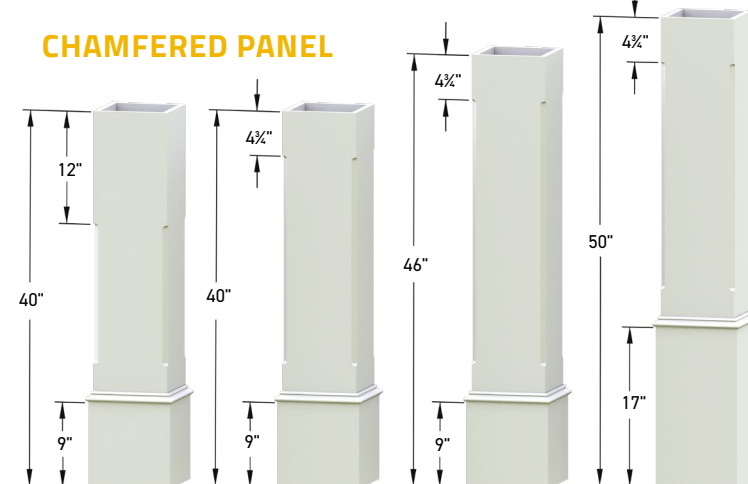

## RECESSED PANEL WITH INLAY

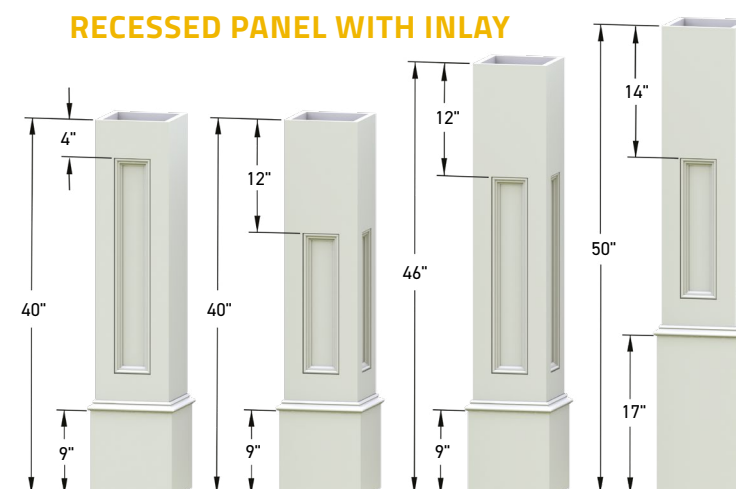

## RAISED PANEL

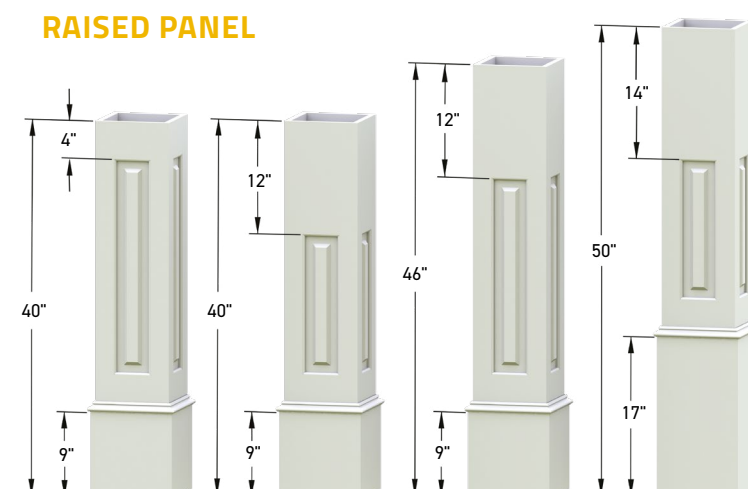

	Chamfered	Recessed	Recessed with Inlay	Raised
Line, Corner, or End Configuration	✗	✓	✓	✓

# Newel Cap Styles NEWEL WRAPS

Choose From Our Selection of Standard Newel Caps or Design Your Own!



Nautilus 20500 3-Line Rail with 2 Tier Plain Cap & 287 Rake Trim (NTRC), Radius Bends, Chamfered 2" Balusters, Recessed Panel Newel Wraps

## STANDARD NEWEL CAPS

- All standard Newel Caps are available as 6", 8", 10", and 12"
- Larger standard and custom sizes are available upon request
- All flat-top Newel Caps are available with Ball Finial



Dartmouth Peaked with 2 Tier Plain Cap & Ball Finial with Flat Panel Newel Wraps, Radius Bends, and Square Web Deco Panels

## STANDARD NEWEL CAP STYLES:



# Custom Newels NEWEL WRAPS

We offer the ability to create Custom Newel wraps to meet your design requirements or for historic restoration!

## CUSTOM NEWEL EXAMPLES

- Multi-Sided Newels
- Directional Newels
- Rectangular Newels
- Historical Recreations

EMAIL QUOTES@INTEXMILLWORK.COM TO QUOTE YOUR CUSTOM NEWEL PROJECT!



Dartmouth Flat with 5" Face 6-Sided 90° Custom Newel Wrap



Liberty RS60275 with 6x12 Recessed Panel with Inlay Rectangular Custom Newel Wrap



Liberty RS60275 with 5" Face 6-Sided 90° Custom Newel Wrap



Hampton Peaked with 6-Sided 135° Flat Panel Newel Wraps

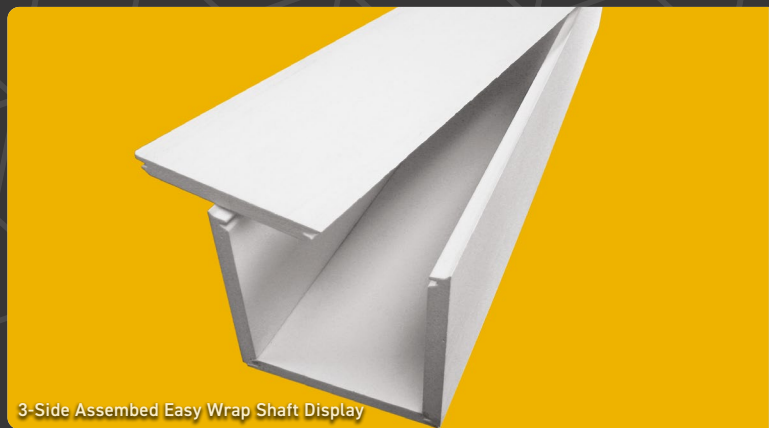

3-Side Assembled Easy Wrap Shaft Display

**EASY WRAPS**  
 Whether you want the most affordable, Knocked Down, shaft only or the pre-assembled system including cap and base, Easy Wrap has a solution for covering your pressure treated or cedar posts.

**PRICE RANGE:**

**INSTALLATION:**



Liberty RS60275 with Black Baluster Infill & Builder Wraps

**BUILDER WRAPS**  
 For a better alternative to Fiberglass columns, use our Builder Wrap at the architectural size of your choice.

**PRICE RANGE:**

**INSTALLATION:**



Recessed Panel Column Wraps

**MILLWORK COLUMN WRAPS**  
 When only the finest will do, our Millwork Column Wraps provide a variety of sizes and panel options for the greatest of curb appeal.

**PRICE RANGE:**

**INSTALLATION:**

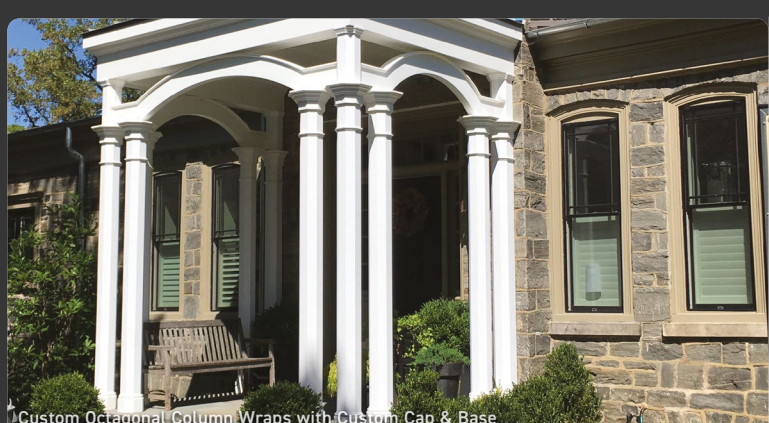

Custom Octagonal Column Wraps with Custom Cap & Base

**CUSTOM COLUMN WRAPS**  
 Whether you need Tapered Columns, Pedestal Bases, or Multi-Sided Columns, our Custom Column Wraps can fit any design requirements.

**PRICE RANGE:**

**INSTALLATION:**

# How to Order COLUMN WRAPS

## STEP 1

- Select Structural Post**  
*INTEX Column Wraps Are Non-Structural*
- Pressure Treated 4x4  
Works With All INTEX Columns
  - Pressure Treated 6x6  
Does Not Fit 6" Column
  - Pressure Treated 8x8  
Does Not Fit 6" or 8" Column

## STEP 2

- Select the Proper Width**  
*Custom Column Widths Also Available*
- 6" Column  
Does Not Fit Over PT 6x6
  - 8" Column  
Does Not Fit Over PT 8x8
  - 10" Column
  - 12" Column

## STEP 3

- Select the Proper Height**  
*Custom Column Heights Also Available*
- 8' Column
  - 9' Column
  - 10' Column
  - 12' Column

## STEP 4

- Select the Panel Detail**
- Flush Panel
  - Recessed Panel
  - Recessed Panel with Inlay
  - Raised Panel
  - Chamfered

## STEP 5

- Select the Panel Orientations**
- Panel 4 Side
  - Split Panel 4 Side
  - Line, Corner, End
- See page 43 for details*

## STEP 6

- Select Cap & Base Style**
- Style H Standard (Included)
  - Style A
  - Style B 164 BC
  - Style C 75 BED
  - Style D 163 CROWN
  - Style E 49 CROWN
  - Style F WM97 CASING

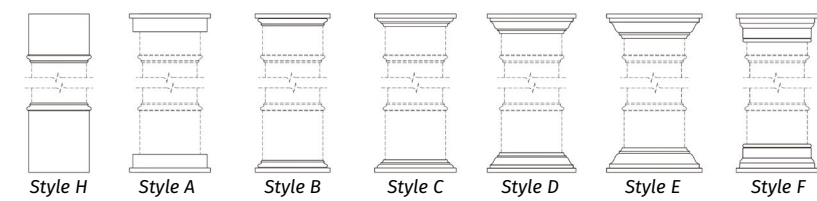

# Section 04 COLUMN WRAPS

# Column Wraps KNOCKED DOWN EASY WRAPS



## Our Most Affordable Column Wrap!

INTEX's Easy Wrap options are economical and easy to install. Save money on product and labor cost by using these innovative post wrap systems! Easy Wraps are compatible with and look great as an addition to all INTEX Rail profiles.

- 100% Cellular PVC
- Available widths: 4 1/2", 5", 6 1/2", 7", 8 1/2" & 9"
- Available heights: 96", 108" and 120"
- Arrives as 4 flat pieces (see image above) for quick & easy installation - no fasteners required!
- Cap and base sold separately
- Does not require paint, but can be painted with a light reflective value (LRV) of 55 or greater



KNOCKED DOWN EASY WRAP SAMPLE  
DISPLAY FULLY ASSEMBLED



GET AN INSTANT QUOTE!  
INTEXMILLWORK.COM

Background Image: Knocked Down Easy Wraps with Trim Rings

# Column Wraps ASSEMBLED EASY WRAPS



## Fastest Column Installation on the Market!

- 100% Cellular PVC
- Available widths: 4 1/2", 5", 6 1/2", 7", 8 1/2", & 9"
- Available heights: 96", 108", & 120"
- Includes 2 Trim Rings
- Arrives 3 sides assembled for quick & easy snap-together installation!
- Does not require paint, but can be painted with a light reflective value (LRV) of 55 or greater



Assembled Easy Wraps with Trim Rings



GET AN INSTANT QUOTE!  
INTEXMILLWORK.COM

# Panel Styles

## MILLWORK COLUMN WRAPS

Column Wraps are shipped in two halves and ready to be incorporated with structural components – typically a Pressure Treated 4 x 4, 6 x 6, or 8 x 8 – for installation.

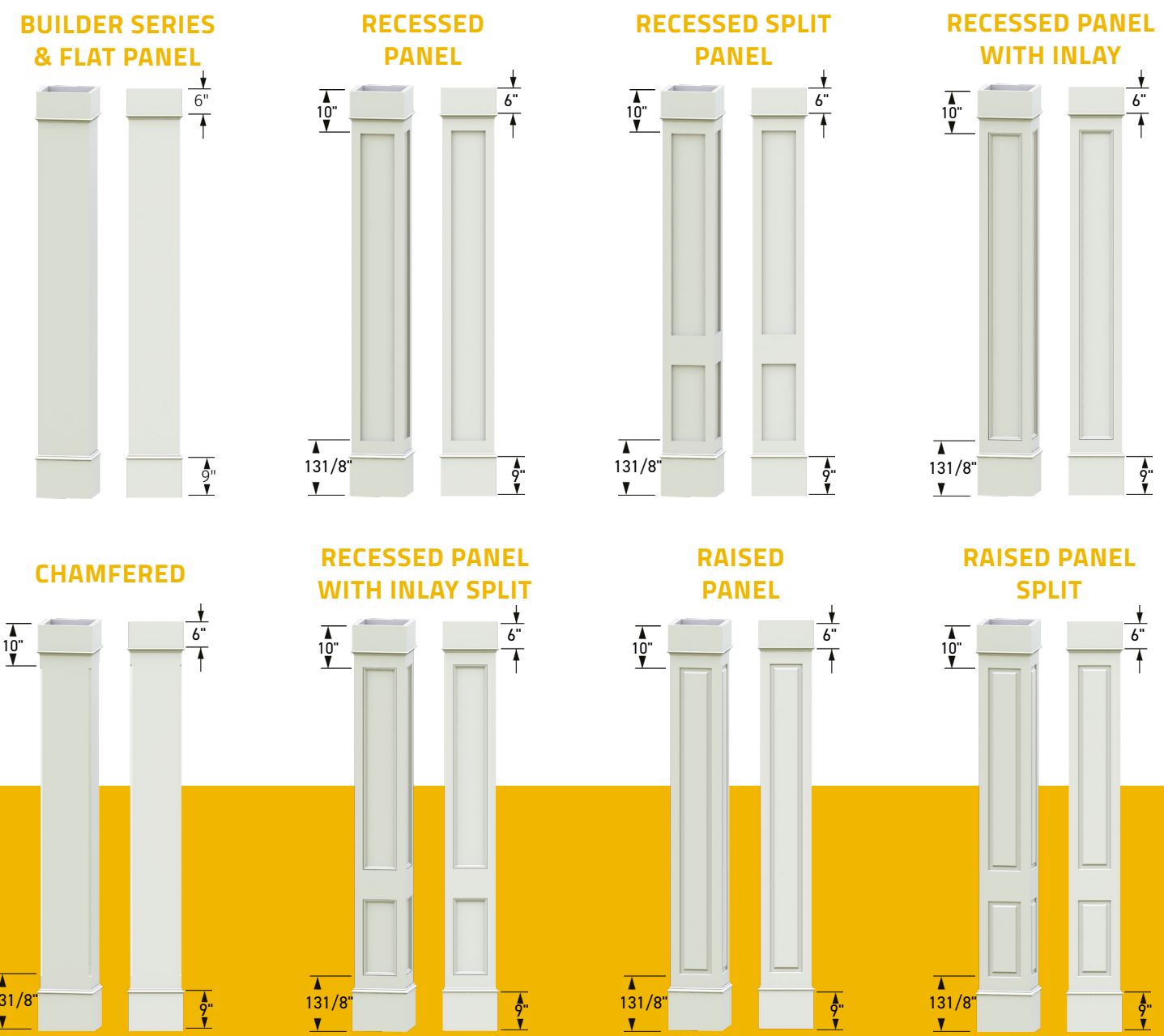

### COLUMN WRAPS

- Standard widths: 8", 10", & 12"
- Standard heights: 8', 9', 10', & 12'
- Custom widths & heights also available

Column Size	Raised or Chamfered	Recessed or Recessed with Inlay
8"	6-3/4"	6" at Center, 6-3/4" at Top & Bottom
10"	8-3/4"	8" at Center, 8-3/4" at Top & Bottom
12"	10-3/4"	10" at Center, 10-3/4" at Top & Bottom

**GET AN INSTANT QUOTE!**  
[INTEXMILLWORK.COM](http://intexmillwork.com)

	Chamfered	Recessed	Recessed with Inlay	Raised
Line, Corner, or End Configuration	✗	✓	✓	✓

# Parametric Ordering

## COLUMN WRAPS

### Parametric Ordering: Custom Column Wrap Sizes

If a standard Column Wrap width or height doesn't work for your application, simply chose a Column Panel Style (page 42) and measure & supply the **WIDTH & HEIGHT** (as pictured, right) to our team!

Parametric Design allows you to order detailed Column Wraps at custom widths and heights at a competitive price point and a standard lead time. Since standard height detailed column wraps cannot be effectively trimmed to height in the field for non-standard height openings, parametric design allows you to maintain architectural integrity without compromising!

**EMAIL QUOTES@INTEXMILLWORK.COM TO QUOTE YOUR CUSTOM COLUMN SIZES!**

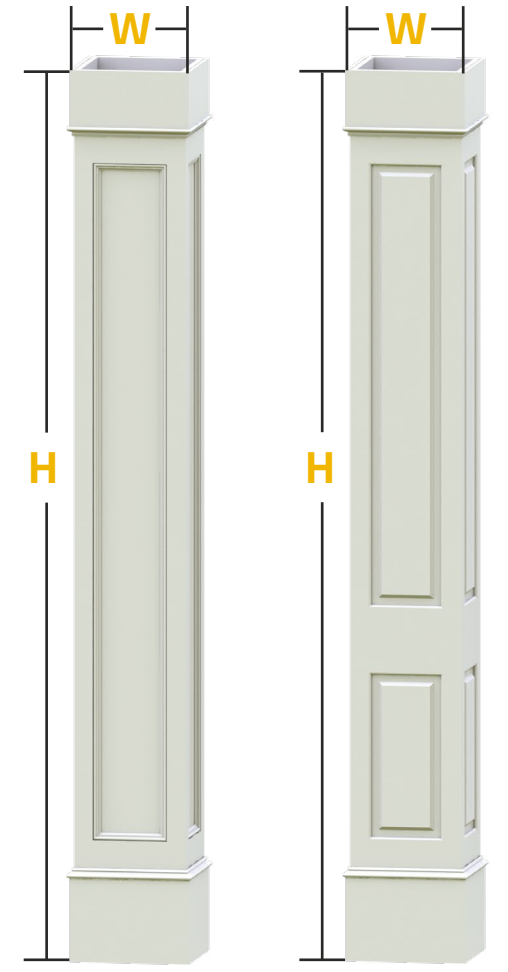

### Panel 4-Side vs. Split Panel 4-Side vs. Line, Corner, End

- Panel 4-Side Wrap does not make accomodation for rail mounting
- Split Panel 4-Side Wrap has check rail for rail mounting (standard check rail height to accomodate 36" rail, all other heights must be custom quoted)
- Line, Corner, & End Column Wraps have full panel on non-rail side, and no panel on rail side

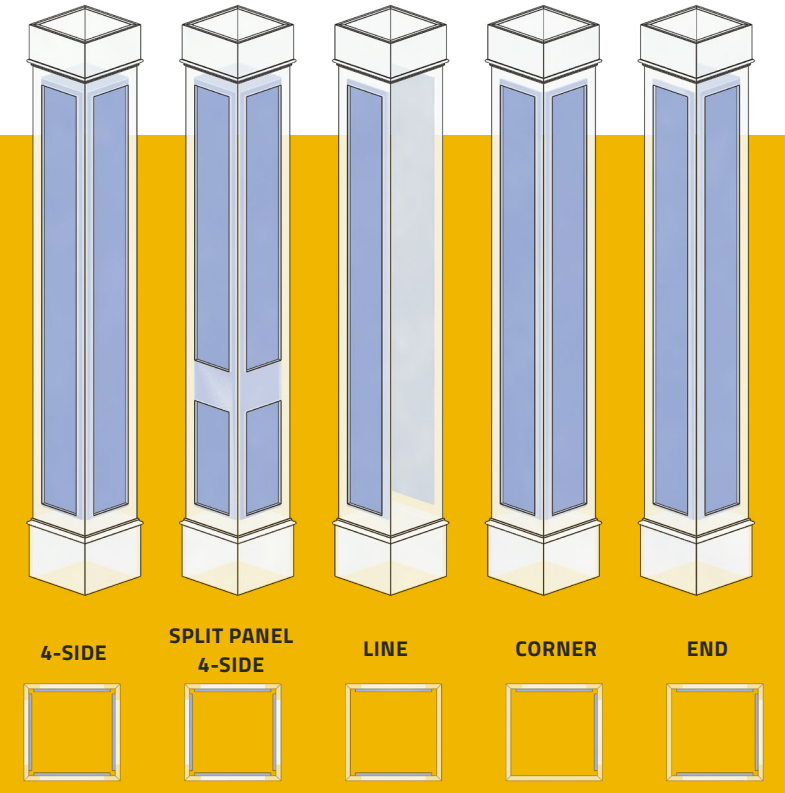

# Custom Columns COLUMN WRAPS

## TAPERED COLUMNS

- Flush, Recessed Panel, Recessed With Inlay, Raised Panel, Chamfered, and custom designs available
- Available in 12"-8", 16"-12", 20" - 14", and custom widths
- Available in 5', 6', 8', and custom heights
- WM75 cap & base included
- Upgraded and custom caps & bases available
- Ships in "L-Halves" and includes adhesive
- Do not require paint, but can be painted with a light reflective value (LRV) of 55 or greater
- Parametric Ordering Tapered Column Sizes: Choose a panel style, measure & supply the **TOP & BOTTOM WIDTHS**, and **HEIGHT** (shown, right image) to our team!



## PEDESTAL BASE

- Available in 12", 16", 20" or custom sizes
- Standard heights available at 40" or 46"
- Flush, Recessed Panel, Recessed With Inlay, Raised Panel, Chamfered, and custom designs available



## CUSTOM COLUMNS

- We offer the ability to create Custom Column Wraps to meet your design requirements or for historic restoration!
- Multi-Sided Column Wraps
  - Directional Column Wraps
  - 1/3 - 2/3 Entasis Column Wraps



**EMAIL QUOTES@INTEXMILLWORK.COM TO QUOTE YOUR CUSTOM COLUMN WRAP PROJECT!**



## CLASSIC PERGOLAS

Classic Pergolas come in standard sizes to give your project all the architectural charm of a traditional wooden pergola, at the lowest cost.

PRICE RANGE: \$ \$ \$ \$

INSTALLATION: ✂ ✂ ✂ ✂



## DELUXE PERGOLAS

Deluxe Pergolas offer the perfect blend of value and customization for your next project. When stock sizes just won't do, choose Deluxe.

PRICE RANGE: \$ \$ \$ \$

INSTALLATION: ✂ ✂ ✂ ✂

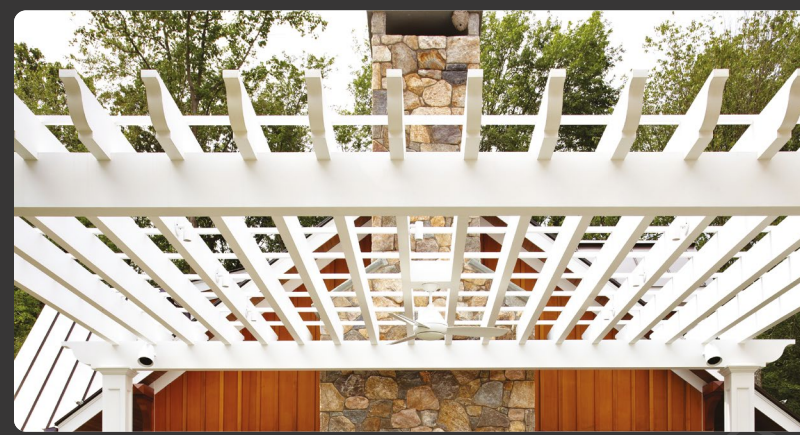

## PREMIUM PERGOLAS

If you need industry leading engineering and spans, our Premium Pergolas are the perfect choice for you.

PRICE RANGE: \$ \$ \$ \$

INSTALLATION: ✂ ✂ ✂ ✂



## CUSTOM PERGOLAS

Do you have an original pergola design you want to make a reality? Let our Custom Pergolas bring your dreams to life.

PRICE RANGE: \$ \$ \$ \$

INSTALLATION: ✂ ✂ ✂ ✂



# Common Features PERGOLA SYSTEMS

Freestanding in a garden, gracing a patio or surrounding a hot tub, a pergola creates a dramatic architectural statement. INTEX Pergola Systems are as strong as they are beautiful, and designed for a secure, easy installation. Enjoy your new outdoor oasis in as little as a weekend.

### ALL INTEX PERGOLA SYSTEMS:

- Low maintenance 100% Cellular PVC with aluminum-reinforced core
- Aluminum core and brackets will not rust, bleed, or corrode
- Complete bracket system for every installation with Stainless Steel screws
- Economical systems available
- Multiple Tail Styles to choose from
- Do not require paint, but can be painted with a light reflective value (LRV) of 55 or greater



Background Image: Two Premium Pergolas

Pergola Systems Comparison	Classic	Deluxe	Premium	Custom*
Rafter Size Options	1	1	2	3
Beam Size Options	1	1	4	4
Maximum Clear Spans	14' x 14'	14' x 14'	20' x 20'	20' x 20'
Design Strength				
Custom Lengths	x	✓	✓	✓
Custom Design Options	x	✓	✓	✓
Standard Tail Designs	4	6	9	9
Custom Tail Designs	x	x	✓	✓
Engineered to International Building Code Requirements	x	x	✓	✓
Bend to Radius	x	x	x	✓
Price				

\*INTEX Millwork Solutions Custom Pergola System is available for projects that need to go beyond the limits of our Premium Pergola System.

# How to Order PERGOLA SYSTEMS

### STEP 1

#### Select a Pergola Line

- Classic Pergola
- Deluxe Pergola
- Premium Pergola
- Custom Pergola

### STEP 2 & STEP 3

#### Select an Orientation, Then Specify Key Dimensions

Step 2: Select An Orientation

- Freestanding Pergola
- Attached To A Ledger

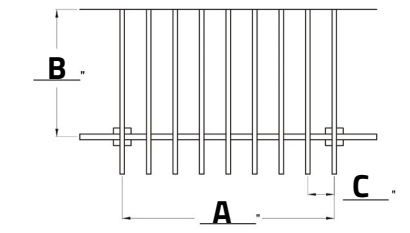
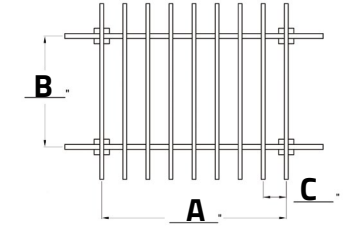

Step 3: Specify All 3 Dimensions

- A. Beam Span \_\_\_\_\_ B. Rafter Span \_\_\_\_\_ C. Rafter On-Center Spacing \_\_\_\_\_

### STEP 4

#### Select Lath Detail

- 5/4 x 3 Flat Lath
- 1-1/2" Square Lath
- 2" x 4" Hollow Purlin with Tails

### STEP 5

#### Select Column Detail & Column Count

All INTEX Pergolas Require A Footing Detail For Structural Purposes, See Installation Instructions For Details

- Pressure Treated 6x6 with INTEX Column Wrap
- Pressure Treated 8x8 with INTEX Column Wrap
- Structural Fiberglass Column by Others
- Number of Columns: \_\_\_\_\_  
*See Page 42 For Column Styles*

### STEP 6

#### Select a Tail Design

Available For All Pergola Lines

- PT1  PT2
- PT3  PT4

Available for Deluxe, Premium, or Custom

- PT5  PT6

Available for Premium or Custom

- PT7  PT8
- PT9

Available for Custom

- Custom Tail Design



GET AN INSTANT QUOTE!  
INTEXMILLWORK.COM



# Classic Series PERGOLA SYSTEMS



14' x 14' Classic Pergola with Builder Series Column Wraps

## All the Architectural Charm of a Traditional Wooden Pergola, at Our Lowest Cost!

The Classic Kit is an economical pergola system designed for small backyard projects. The Classic Kit gives you a quick off-the-shelf solution for your freestanding or attached to structure pergola project.

- One rafter size
- One beam size
- Standard sizes only (8ft, 10ft, 12ft & 14ft post centers)
- Lightweight design
- Economically priced
- Clear spans up to 14' x 14'
- Modest rafter and beam profile
- Four standard tail styles

### CLASSIC PERGOLA TAIL STYLES



 **GET AN INSTANT QUOTE!**  
INTEXMILLWORK.COM

# Deluxe Series PERGOLA SYSTEMS



Deluxe Pergola with Flat Panel Column Wraps

## A High Quality Pergola System With Options That Can Be Customized

The Deluxe Pergola is the perfect finishing touch for your outdoor living space!

- One rafter size
- One beam size
- Custom lengths and multiple design options
- Larger dimension components for a traditional wood frame look
- Moderately priced
- Clear spans up to 14' x 14'
- Larger rafter & beam profile than classic kit
- Six standard tail styles

### DELUXE PERGOLA TAIL STYLES

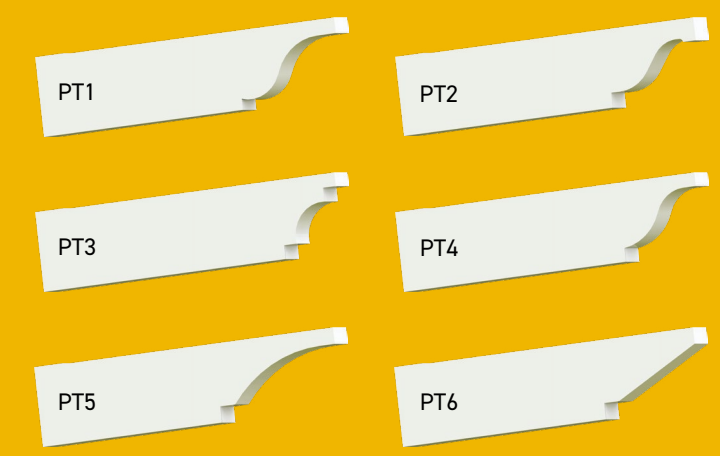

 **GET AN INSTANT QUOTE!**  
INTEXMILLWORK.COM

# Premium Series PERGOLA SYSTEMS



Two Premium Pergolas with Flat Panel Column Wraps with Custom Cap & Base

## The Premium Pergola Allows You To Customize Your Pergola To Meet Your Project Specifications!

The substantial design of the Premium Pergola System is engineered to meet international building code for commercial and residential applications.

- Two rafter sizes
- Two beam sizes
- Custom lengths and multiple design options
- Larger rafter and beam profile than deluxe
- Engineered to meet the requirements of the international building code for 1" ice load, 120 mph wind up-lift (not all photos are engineered pergolas)
- Clear spans up to 20' x 20'
- Heavy duty engineered design
- Nine standard tail styles with the option to create a custom tail design

### PREMIUM PERGOLA TAIL STYLES



 **GET AN INSTANT QUOTE!**  
INTEXMILLWORK.COM

# Custom PERGOLA SYSTEMS



Custom J-Shaped Pergola with Recessed Split Panel Column Wraps with Inlay

## Let Our Custom Pergola Systems Bring Your Outdoor Living Dreams To Life!

- Custom layouts and footprints available
- Clear spans up to 20' x 20'
- Standard and custom beam, rafter, and lath sizes available
- Radius beams & rafters
- Arched rafters
- Gable rafters
- Nine standard tail styles, or design your own custom tail profile!

**EMAIL QUOTES@INTEXMILLWORK.COM TO QUOTE YOUR CUSTOM PERGOLA PROJECT!**

### CUSTOM PERGOLA TAIL STYLES



# The INTEX Difference

INTEX Cellular PVC pergola components are sleeved over structural aluminum internal reinforcements to provide strength and durability. Truly the finishing touch that stands the test of time.



WOODEN PERGOLA - BEFORE



PERGOLA ENGINEERED & RECREATED BY INTEX



# Classic & Deluxe TRELLIS SYSTEMS

### Boasting Fine Craftsman Style and Gorgeous Architectural Details



Deluxe Garage Trellis

#### CLASSIC TRELLIS

- Fixed beam spans –8', 9' 10', 12', 14'
- 17 3/8" X 16 1/2" x 3" bracket
- 2" X 5 1/2" beam
- 1 1/2" X 1 1/2" x 17 3/8" purlins
- 4 tail styles (PT1 - PT4)

#### AVAILABLE FOR CLASSIC OR DELUXE

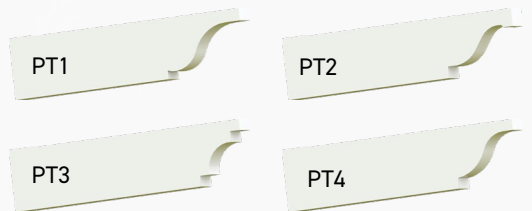

#### DELUXE TRELLIS

- Custom beam spans up to 16'
- 29 5/8" X 30 x 5 1/2" bracket
- 2 1/2" X 7 3/16" beam
- 2" X 4" x 32" purlins
- 9 Tail styles (PT1 - PT9), or create a custom tail design

#### AVAILABLE FOR DELUXE ONLY

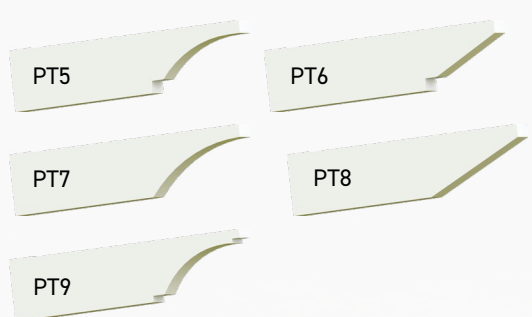

## How to Order TRELLIS SYSTEMS

### STEP 1

#### Select a Trellis Line

- Classic Trellis
- Deluxe Trellis

### STEP 2

#### Select Number of Structural Brackets

- 2 Brackets Only
- More Than 2 Brackets  
Number of Brackets: \_\_\_\_

### STEP 3

#### Specify Key Dimension

- Bracket Center to Bracket  
Center Dimensions

### STEP 4

#### Select Purlin Detail

Available For Classic or Deluxe

- 1 1/2" Square

Available For Deluxe Only

- 2 x 4 Purlin with Tail

### STEP 5

#### Select a Trellis Tail Design

Available For Classic or Deluxe

- PT1
- PT2
- PT3
- PT4

Available For Deluxe Only

- PT5
- PT6
- PT7
- PT8
- PT9
- Custom Tail Design



Deluxe Garage Trellis



Recessed Panel with Inlay Window Box

### ARCHITECTURAL MILLWORK

From Shower Enclosures to Mailbox Posts and Planter Boxes, we offer Landscape Millwork products in many designs, shapes and sizes. These elements will complement your yard or terrace with lasting charm!



Louver Shutters With Optional Hardware, Pre-finished in Black

### SHUTTERS, HOLLOW BRACKETS & HOLLOW RAFTER TAILS

Every detail matters. Add the finishing touches to every area of your exterior with our Shutters, Hollow Brackets, and Hollow Rafter Tails - perfectly crafted to your specifications.



Window Surrounds, Hollow Rafter Tails, Window Boxes

### CUSTOM MILLWORK & MORE

Traditionally renovating a historic home used to be challenging due to custom woodworking which would rot with time. Now, we have a solution with custom PVC millwork.



Window Surrounds & Entry Systems

### WINDOW SURROUNDS, ENTRY SYSTEMS, MOULDING & TRIM

A home isn't finished until it's dressed in a style all its own. Accentuate your home's existing architecture by working with our Design Team to create custom designs or to meet historic renovation requirements.



## Section 06 MILLWORK & MORE

# Estate Series FENCE SYSTEMS



Estate Series Fence

## Add A Delicate Accent To A Garden, Or Surround An Estate With Prominent Architectural Features!

We combine prominent profile features with a simple drop-together installation with minimal on-site tool requirements and hidden fasteners.

- 100% Cellular PVC
- Available in a variety of styles and sizes (visit [intexmillwork.com](http://intexmillwork.com) for more information)
- Reinforced aluminum core for strength & corrosion resistance
- Gates structurally reinforced with welded frame
- Aesthetically pleasing shadow lines
- Rackable or stepped for grade adjustment
- Low maintenance and easy to clean
- Does not require paint, but can be painted with a light reflective value (LRV) of 55 or greater

### EXCEPTIONAL STRENGTH

- A. Aluminum reinforced top and bottom rails for fence sections.
- B. Two part post reinforcement for applications including gates, in-line reinforcement, and masonry or hard substrate mounting.
- C. Exploded view of structurally reinforced gate.

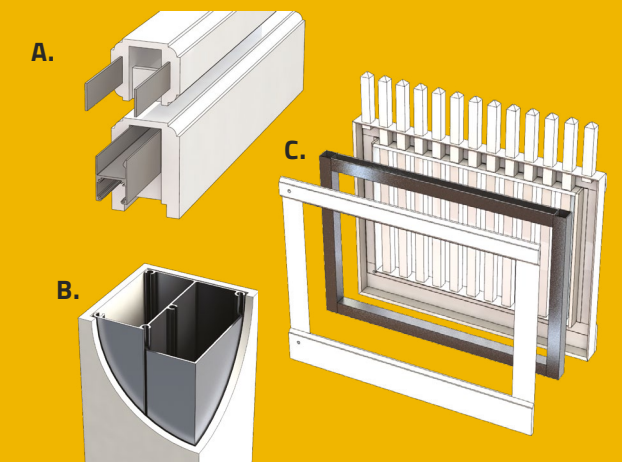

# Shower Enclosures ARCHITECTURAL MILLWORK



## Complete Your Outdoor Oasis With A Low-Maintenance Shower Kit!



### SHOWER ENCLOSURE FEATURES

- 100% Cellular PVC
- Available in open or closed back
- Complete kits available
- Beaded (left image) or Flush (right image) detail wall panels
- Reinforced aluminum core for strength & corrosion resistance
- Low maintenance and easy to clean
- Do not require paint, but can be painted with a light reflective value (LRV) of 55 or greater

### STANDARD SIZES

- 4' x 4' Open Back Kit
- 4' x 4' Closed Back Kit
- 4' x 8' Open Back Kit
- 4' x 8' Closed Back Kit

### CUSTOM SHOWER ENCLOSURES

Custom layouts are available by request.  
Email [quotes@intexmillwork.com](mailto:quotes@intexmillwork.com)

# Boxes & Posts ARCHITECTURAL MILLWORK

### WINDOW BOXES

- Standard heights available at 9" h x 11 1/2" projection
- Standard widths available at 32", 36", 40"
- Standard panel details of Flush, Recessed, Recessed with Inlay, & V-Groove
- 3 standard styles of support brackets available
- Custom size boxes and support brackets available upon request - email [quotes@intexmillwork.com](mailto:quotes@intexmillwork.com)



Recessed Panel with Inlay Window Box

### PLANTER BOXES

- Standard heights & depths available at 12", 14", 16", 18"
- Standard widths available at 30", 40", 46"
- Standard square planters available at 16" x 16" x 16" & 18" x 18" x 18"
- Standard panel details of Flush, Recessed, Recessed with Inlay, & V-Groove
- Custom size boxes available upon request - email [quotes@intexmillwork.com](mailto:quotes@intexmillwork.com)



Recessed Panel Planter Box

### DELUXE MAILBOX POSTS

- Deluxe 5" x 5" Mailbox Post includes Arm, Decorative Bracket, Mailbox Plate, & Post Cap
- Mailbox base adders available as Smooth Panel, Recessed Panel, & Recessed Panel with Inlay



Deluxe Recessed Panel with Inlay Mailbox Post

### DELUXE LAMP POSTS

- Deluxe 5" x 5" Lamp Post includes Flat Cap
- Lamp post base adders available as Smooth Panel, Recessed Panel, & Recessed Panel with Inlay
- Cap includes a 3" diameter collar for mounting a lantern
- Cap & Post are pre-drilled for wiring
- Optional 24" sign arm available



Deluxe Lamp Post

# Shutters ARCHITECTURAL MILLWORK

### Engineered To Out-Perform Wood, Polypropylene, Polyethylene And Aluminum Shutters

LOUVERED



BEADED RAISED PANEL\*



RAISED PANEL\*



FLUSH FLAT PANEL



- Built to custom sizes
- Stainless Steel, powder-coated hardware system available
- Historically accurate
- Approved for historic restoration
- Termite proof; will not rot or warp
- Available in 11 pre-finished colors, or unfinished to be painted with a premium acrylic coating (including dark colors)
- Unfinished Shutters will need to be finished with a solar reflective paint before installation
- Louvered available with or without Horns



4 Shutter Styles



Optional Hardware



Paintable to Any Color

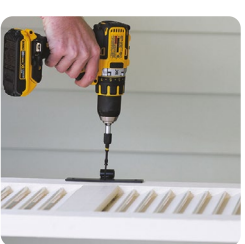

Easy Installation

\*The rear detail of Beaded Raised Panel and Raised Panel is the same as the front of Flush Flat Panel.

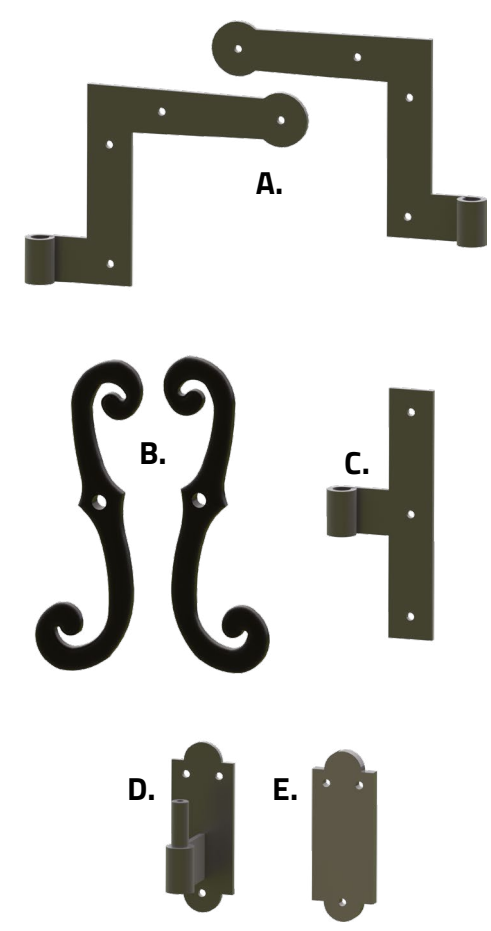

### Optional Shutter Hardware Pack Includes The Following:

- A. 4 New York "L" Style Hinges, 2 Lefts, 2 Rights; Mounting Screws Included
- B. 2 Shutter Dogs with Mounting Brackets 1 Left, 1 Right; Mounting Screws Included
- C. 2 New York Style Mid Hinges; Mounting Screws Included
- D. 6 Pintels; Mounting Screws Included
- E. 6 Pintel Shims; Mounting Screws Included

### Choose From 11 Pre-Finished Colors!



The above color swatches are digitally printed representations and may not be 100% accurate. Please request a paint swatch card from your INTEX Dealer! Shutters can be supplied unfinished to be painted with a Premium Acrylic Coating.

# Hollow Brackets ARCHITECTURAL MILLWORK

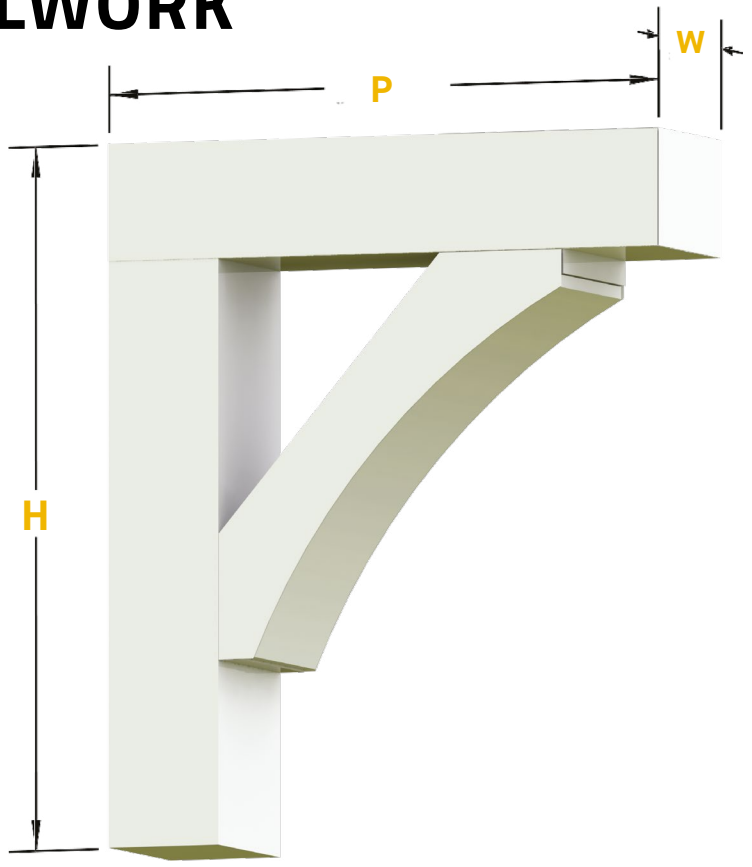

## Parametric Ordering Information

- STEP 1**  
Select one of our four standard designs
- STEP 2**  
Measure the **WIDTH** needed
- STEP 3**  
Measure the **PROJECTION** needed
- STEP 4**  
Measure the **HEIGHT** needed

# Hollow Rafters Tails ARCHITECTURAL MILLWORK

## Parametric Ordering Information

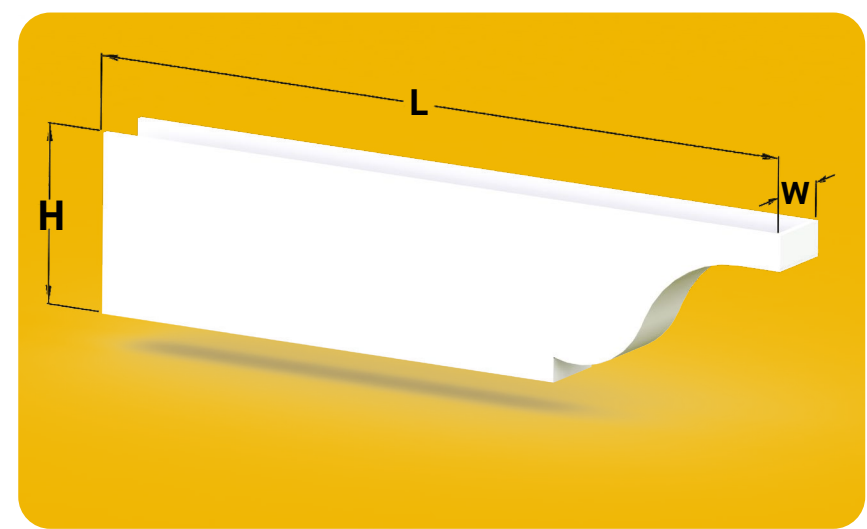

- STEP 1**  
Select one of our nine standard designs
- STEP 2**  
Measure the **WIDTH** needed
- STEP 3**  
Measure the **HEIGHT** needed
- STEP 4**  
Measure the **LENGTH** needed

## Hollow Brackets - 4 Standard Styles

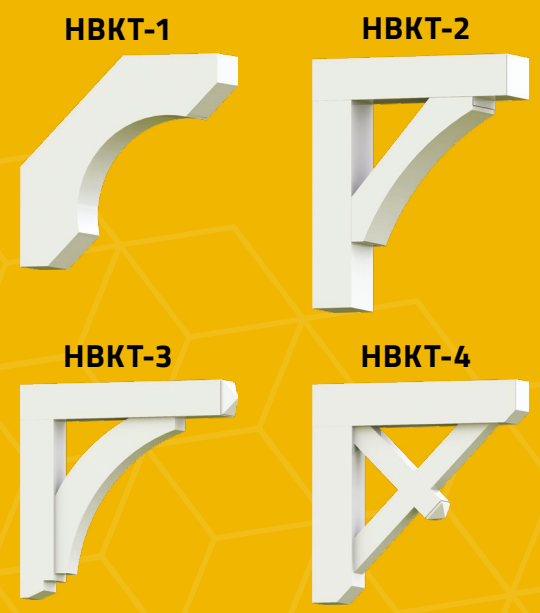

CUSTOM STYLES ARE AVAILABLE BY REQUEST!  
EMAIL QUOTES@INTEXMILLWORK.COM

## Hollow Rafter Tails - Lightweight Design with 9 Styles!

- Laminated end-detail and a PVC skin on all tail faces eliminates exposed, open cells
- Hollow design allows for easy installation with blocking or covering existing rafter tails
- Beautiful, sharp lines
- Custom sizes & patterns available by request
- Do not require paint, but can be painted with a light reflective value (LRV) of 55 or greater

### STANDARD TAIL STYLES:



Custom Hollow Rafter Tails



# Custom Millwork & More ADDITIONAL CAPABILITIES

## Our Team Of Skilled Craftsmen Offer Limitless Custom Millwork Design Options!



Custom Circle-Top, Radius Recessed Panel Window Surround with Keystone

From intricate details to innovative finishing touches, INTEX PVC custom millwork is created using advanced CAD design technologies, state-of-the-art fabrication equipment and hand-crafted techniques once reserved only for wood.

**CRAFTSMANSHIP THAT YOU CAN TRUST**  
Architects and builders rely on INTEX's strengths in both traditional workmanship and engineering technology to craft intricately detailed, high-quality millwork for distinctive homes and buildings.

- CUSTOM MILLWORK CAPABILITIES:**
- Produced to precise design specifications, fabricated to order, packaged securely so that product arrives damage free – ready for installation.
  - Custom replication of brackets and other architectural details allow for a more accurate restoration.
  - Custom lattice and panels provide a stylish sense of security.
  - Custom railings and balusters per architect specs give a unique, elegant look.



Hampton Flat with 5" Newel Wraps & Flat Panel Column Wraps

## Commercial Applications

**OUR ENGINEERED PRODUCTS MEET INTERNATIONAL BUILDING CODE**

You can count on the unsurpassed performance of INTEX's engineered systems. Innovative technology and fine craftsmen give INTEX the ability to meet any design specification. The easy to install INTEX "system" approach will also lower your construction labor costs.

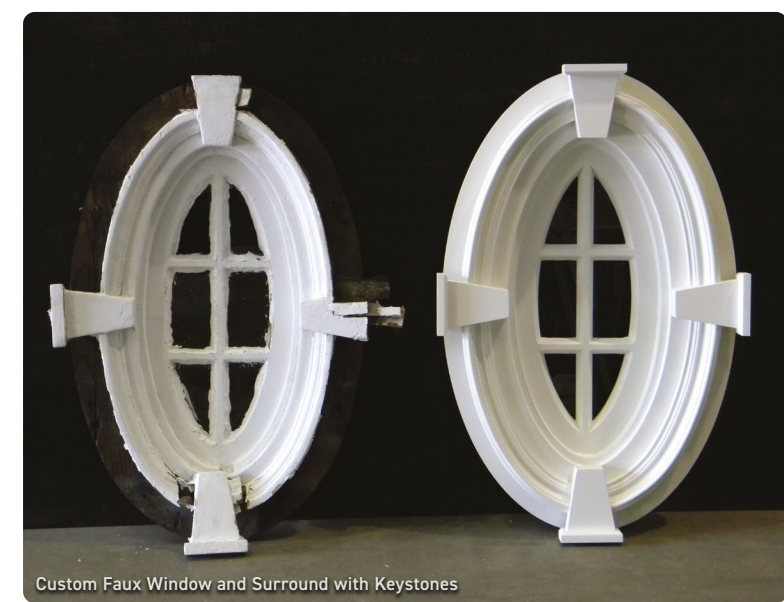

Custom Faux Window and Surround with Keystones

## Historic Restorations

**THE ABILITY TO MATCH EXACT DETAILS & CRAFTSMANSHIP OF THE ORIGINAL MILLWORK**

The experienced skilled craftsmen at INTEX have the knowledge and creativity to protect and preserve your home's architectural heritage. By using INTEX's talent and innovative technology, intricate ornamental detailing and exquisite finishing touches can be readily created.

# Custom Millwork & More ADDITIONAL CAPABILITIES



Boston Gutter with Scotia Trim

## BOSTON GUTTER SYSTEM

With the full aesthetic appeal of wood, but the low-maintenance of extruded Cellular PVC, our Boston Gutter System brings another level of sophisticated detail to your home. Available in 10 and 20 foot lengths, and radius bends up to 18 feet in length, your Boston Gutter System is crafted to perfectly fit your needs. As with any gutter system, it is important to clean debris from the gutter periodically to ensure proper drainage.



Custom Arch-Top Window Surround

## WINDOW SURROUNDS

A home isn't finished until it's dressed in a style all its own. Accentuate your home's existing architecture by using window surrounds. INTEX Window Surrounds can be manufactured to fit any shape or size window. With our large selection of frame, crown and sill options, INTEX surrounds save time and eliminate scrap connected with building surrounds on-site.



Custom Mouldings & Trim

## MOULDINGS & TRIM

We fabricate mouldings from solid, cellular PVC boards using the same techniques as mills providing wood mouldings. Mouldings are milled to standard industry patterns, and sanded, primed and ready for installation. Custom milling is available to match existing profiles, or to satisfy any design specification required for your project!



Custom Entry System with Pediment Head

## ENTRY SYSTEMS

Transform a typical front door into a 'welcome home' statement. With choices of trim styles, headers and pediments, there are over 100 combinations - just right for any house style. Custom Entry Systems can be created for Historic Restoration, or for your unique style. Our trained staff will even assist on-site for complex door configurations!

# For the Architect EDUCATION & MORE

## RESOURCES

We understand how important your reputation is — every structure you build needs to meet your clients' standards, and with INTEX Millwork Solutions, you can rest assured that your projects will exceed expectations.

intexmillwork.com hosts important architectural resources, from DWG and PDF drawings, to Revit downloads, to our comprehensive installation instructions, and more. Every detail is considered to make your job easier!

## AIA & LA CES CONTINUING EDUCATION

INTEX Millwork Solutions recognizes the importance of continuing education in architecture and is very proud to be a registered provider with AIA.org and ASLA.org (LA CES).

Our Sales Reps are happy to host a class at your office, at our facility in Mays Landing, NJ, or via video conferencing.

Classes (including our accredited Plant Tour) hosted at our facility will enjoy a tour of our new shop floor and a detailed overview of our brand new show room.



Lathe Turning a Custom Baluster at INTEX Millwork Facility

## Available AIA and LA CES Courses

### INTEXTOUR: INTEX Millwork Plant Tour | 2 AIA LU

Students will experience a detailed, inside look at the manufacturing process of INTEX Millwork Products. They will see first hand the entire production process, from raw materials to finishing, engineering, estimating, packaging and more.

### INTEX20150126: Understanding the Benefits of Cellular PVC Rails and Pergolas | 1 AIA LU | 1 LA CES PDH

Students will gain a basic understanding of the benefits of specifying cellular PVC (Poly Vinyl Chloride) railing systems, pergolas and gutters for residential and commercial construction projects. Traditional materials like wood, vinyl, and composite materials have been the standard choices available for years, but these materials pose several challenges in aesthetics, durability, affordability, and limited design options.

### INTEX-POOLCODE: Swimming Pool Enclosure Code Requirements Explained | 1 AIA LU, HSW | 1 LA CES PDH

Students will learn the details of swimming pool enclosure code requirements to ensure specific design and materials meet standard building code criteria for barrier and access requirements.

### INTEX2020HSW: Hand Rail Code Requirements & Design Considerations | 1 AIA LU, HSW

Students will learn the details of railing systems code requirements and testing to ensure they meet IRC and IBC Building Codes. Integrating design elements based on materials and span limits into the structure architecture.

## FREQUENTLY ASKED QUESTIONS

### CAN INTEX PRODUCTS BE PAINTED?

Yes, due to the inherent expansion and contraction characteristics of PVC, INTEX's PVC millwork products should only be painted colors with an LRV (light reflective value) greater than 55.

### HOW DO YOU CLEAN CELLULAR PVC?

Cleaning all INTEX products are easy and fast with most major household cleaners. For specific recommendations and instructions, visit [intexmillwork.com](http://intexmillwork.com). Harsh cleaners with glycol ethers or ethanol type solvents and/or isopropyl alcohol are not recommended.

### HOW LONG DO INTEX PRODUCTS LAST?

INTEX products are designed to last in the harshest of environments. For this reason, all INTEX Millwork Solutions products carry a lifetime limited warranty.

### WHERE CAN I PURCHASE INTEX PRODUCTS?

Visit [intexmillwork.com](http://intexmillwork.com) to find an authorized dealer near you.



**INTEX**<sup>®</sup>  
MILLWORK SOLUTIONS

## INTEX Millwork Solutions, LLC

45 Mill Street • Mays Landing, NJ 08330

(856) 293-4100

[intexmillwork.com](http://intexmillwork.com) | [#intexmillwork](https://twitter.com/intexmillwork)

©2023-2024, INTEX Millwork Solutions, LLC

2023-1 Printing

Front Cover Image: Hampton Peaked with  
Flat Panel Newel & Column Wraps

# Product Catalog 2023

[intexmillwork.com](http://intexmillwork.com)