

ELEVATE

MARVIN ELEVATE™ COLLECTION



THE MARVIN PORTFOLIO

Inspired by how people live, the Marvin portfolio is organized into three product collections—defined by the degree of design detail and customization opportunities. Our thoughtful solutions provide exceptional performance, energy efficiency, low maintenance, and quality you can see, feel, and touch, making it easy to bring your vision to life.

MARVIN SIGNATURE™ COLLECTION

Previously known as Marvin Windows and Doors
Includes Ultimate and Modern product lines



Featuring the Ultimate and Modern product lines, the Marvin Signature collection offers the broadest range of product types, sizes, configurations, and design options. Every detail is considered, delivering the highest level of architectural correctness and unrivaled appeal.

← LEVEL OF DESIGN DETAIL AND CUSTOMIZATION

More Flexible

MARVIN ELEVATE™ COLLECTION

Previously known as Integrity Wood-Ultrex



The Elevate collection is thoughtfully designed to offer specifically-chosen features and options to help make your vision a reality. Warm wood interiors with strong, durable, Ultrex® fiberglass exteriors, provide the ideal combination of beauty and strength.

MARVIN ESSENTIAL™ COLLECTION

Previously known as Integrity All Ultrex



The Essential collection makes it easy to achieve design and quality with clean lines, streamlined options, and powerful performance. Strong, durable, Ultrex fiberglass interiors and exteriors mean windows and doors that are virtually maintenance free.

LEVEL OF DESIGN DETAIL AND CUSTOMIZATION →

More Streamlined



Picture windows with custom stain

Marvin Elevate™ Collection

THE PERFECT BALANCE OF BEAUTY AND STRENGTH

Balancing beautiful design with superior strength, the Marvin Elevate collection delivers style in any climate. Previously known as Integrity Wood-Ultrex®, Elevate features warm wood interiors that can blend in or stand out, with Ultrex fiberglass exteriors for lasting durability. The collection offers a range of carefully selected features and options, making it as versatile as it is elegant.

About Us

At Marvin, we're driven to imagine and create better ways of living, helping people feel happier and healthier inside their homes. We believe that our work isn't just about designing better windows and doors—it's about opening new possibilities for the people who use them.



Bi-parting Sliding French door with Northfield hardware in Oil Rubbed Bronze



TABLE OF CONTENTS

8	WHY MATERIALS MATTER
12	ENERGY EFFICIENCY
14	DESIGNED WITH PROS IN MIND
16	WINDOWS + DOORS
18	CASEMENT + AWNING
20	DOUBLE HUNG
22	GLIDER
24	PICTURE
26	BAY + BOW
28	ROUND TOP
30	ALUMINUM ROUND TOP
32	SPECIALTY SHAPES
34	SLIDING PATIO DOOR
36	SLIDING FRENCH DOOR
38	INSWING FRENCH DOOR
40	OUTSWING FRENCH DOOR
42	PRODUCT OPTIONS
44	INSTALLATION ACCESSORIES
45	EXTERIOR TRIM
46	DESIGN OPTIONS
48	HARDWARE STYLES
50	WINDOW SAFETY

WHY MATERIALS MATTER

THE MARVIN MATERIALS DIFFERENCE: ULTREX FIBERGLASS

Choosing the right materials for windows and doors is important when it comes to long-term appearance and performance. Ultrex®, an innovative fiberglass material pioneered by Marvin over 20 years ago, was one of the first premium composites on the market. However, not all composites are created equal.

- Some companies use materials like sawdust and vinyl to produce a composite material with fundamentally different properties and performance values. But Ultrex is different. Its material makeup contains a high density of woven fibers bound by a thermally-set resin that makes it more resistant to pressure and temperature than vinyl-based composites.
- With such different materials grouped in the composites category, it becomes important to know what sets them apart.



STRENGTH AND STABILITY OF ULTREX

Ultrex fiberglass is highly impact resistant and more rigid than vinyl and vinyl/wood composites. Issues of instability and less-than-perfect alignment that can complicate installation—and long-term performance—are not a concern with Elevate collection windows and doors.

The exceptional strength and stability of Ultrex eases installation and establishes a secure, long-lasting fit that stays square and true, year after year.

PULTRUDED FIBERGLASS

Thin strands of strong glass cables, saturated with compounded resins create a durable material.

PATENTED FINISH

The patented finishing process applies an impermeable and AAMA 624 verified factory finish.





Double Hung windows and Inswing French doors with swinging screens

ULTREX FIBERGLASS: QUITE POSSIBLY
THE PERFECT BUILDING MATERIAL®

WHY MATERIALS MATTER

TEMPERATURES MAY FLUCTUATE, BUT ULTREX WON'T

Ultrex® expands and contracts at virtually the same rate as glass so it works with glass rather than against it. This means seals aren't as prone to leaking and windows aren't subjected to sagging issues like other composites.

This is especially true when compared to vinyl, which can distort in extreme heat and crack in fluctuating temperatures. Ultrex resists distortion even at temperatures up to 285°F. Rapid temperature change doesn't faze Ultrex. From -30°F to 70°F, a 6 foot stile changes less than 1/32 inch in length.

EXPANSION MEASUREMENT

Ultrex expands and contracts at virtually the same rate as glass.

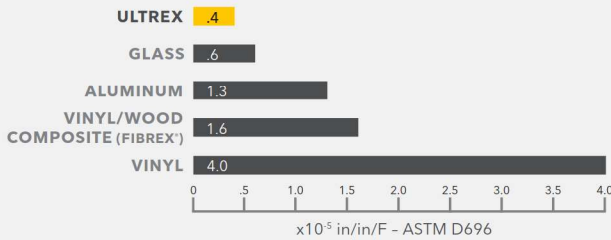

INDUSTRY'S BEST FIBERGLASS FINISH FOR LASTING BEAUTY

Ultrex is the first and only fiberglass finish to be verified to AAMA's 624 voluntary finish specifications for fiber reinforced thermoset profiles (fiberglass).

Windows and doors made with Ultrex resist scratches, dings, and marring more than vinyl. Our patented, mechanically bonded acrylic finish is up to three times thicker than painted competitive finishes, and it resists UV degradation up to five times longer than vinyl—even on dark colors.

PATENTED ACRYLIC CAP



Casement and Double Hung windows in Bronze



Picture windows in Bronze

COOLER IN SUMMER, WARMER IN WINTER

TOP RATED ENERGY EFFICIENCY

The National Fenestration Rating Council (NFRC) defines energy performance ratings for the entire window and door industry. It rates:

- **U-factor:** How well a window keeps heat inside a building.
- **Solar heat gain:** A window's ability to block warming caused by sunlight.
- **Visible light transmittance:** How much light gets through a product.
- **Air leakage:** Heat loss and gain by air infiltration through cracks in the window assembly.

Ultrex® fiberglass is 500 times less conductive than roll-form aluminum and is similar to wood and PVC. It provides an insulated barrier against extreme weather temperatures, keeping homes comfortable, and reducing heating and cooling costs.

ENERGY COST SAVINGS

Marvin was the first major window and door manufacturer to offer energy-efficient Low E2 glass and ENERGY STAR® certified performance on all of our standard windows and doors. Compared to non-certified products, ENERGY STAR certified windows and doors cut heating and cooling costs by 12%.*

The Elevate collection offers Triple-pane, Low E1, Low E2, Low E3, and Low E3/ERS insulated glass with argon gas, which has thermal conductivity 30% lower than that of air. It adds improved solar and thermal protection by distinguishing between visible light, damaging UV, and near-infrared rays to offer the ultimate glass performance, and provides a selection of energy-efficient solutions depending on your climate and needs.

LOW E GLASS COATING

The Low E coating is specially designed to take advantage of the angle of the winter and summer sun. Winter sun is absorbed and conducted indoors. Summer sun is filtered and reflected back outdoors.

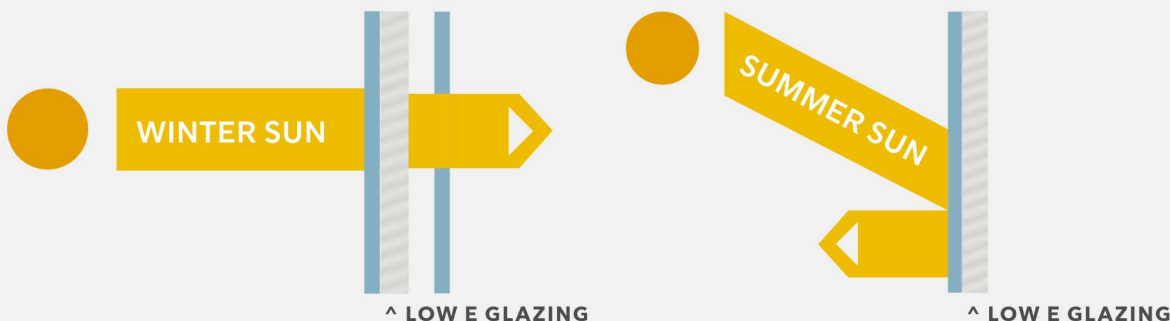



A MORE COMFORTABLE INTERIOR, REGARDLESS OF THE SEASON

Keep heat inside during cooler weather and block the sun's rays during warmer weather with Dual Pane windows and Low E coating.

DESIGNED WITH PROS IN MIND

PEACE OF MIND

Every project has its own unique requirements and Marvin is equipped to meet those challenges. Our unique Ultrex® fiberglass construction, available factory services, unmatched delivery, and network of dedicated service and support personnel make the Elevate collection the perfect choice—no matter the project.

**FAST & EFFICIENT
DELIVERY**

EASY TO ORDER, SIMPLE TO INSTALL

The Elevate collection offers simplified options to make the order process straightforward. Installation options and accessories make installing Marvin easier than ever. See page 44 for more information.

MARVIN HAS YOU COVERED

The Elevate collection is backed by a fully transferable 20/10 warranty—20-year coverage on glass, and 10-year coverage on manufacturing materials and workmanship.



Picture and Casement windows in Pebble Gray



CREATING VALUE AND EFFICIENCY EVERY STEP OF THE WAY

Weather-tight, solid, and durable Ultrex fiberglass means there are virtually no call-backs. Elevate window and door profiles are optimized for the maximum in performance and fit.



Casement and Picture windows in Bronze

Marvin Elevate™ collection

WINDOWS + DOORS



CASEMENT + AWNING



Picture and Casement windows with Oil Rubbed Bronze hardware



Casement and Awning Narrow Frame windows with Satin Nickel hardware

CASEMENT + AWNING

- Multi-point sequential locking system provides superior PG50 performance rating with single lever operation.
- Interior screen features an aluminum surround and concealed pressure mounting points for ease of operation and enhanced aesthetics.
- Operating, transom, and picture units available.
- Folding handle neatly stows out of the way. Stainless steel coastal hardware available.
- Casement available in standard and special sizes up to 3 feet wide by 6 feet high.
- Awning available in standard and special sizes up to 4 feet wide by 4 feet high.
- Coordinating Picture and Transom windows also available.
- Narrow frame option with 3 ¼ inch insert replacement frame, flat sill, and through jamb installation.



CASEMENT + AWNING



CASEMENT NARROW FRAME + AWNING NARROW FRAME



Available with IZ3
(Excludes Narrow Frame option)

DOUBLE HUNG



Double Hung windows with Oil Rubbed Bronze hardware



Double Hung windows with Window Opening Control Devices

DOUBLE HUNG

- Equipped with a standard full screen; optional half screen is available.
- Tilt latches are ergonomically designed and easy to operate making tilting and cleaning effortless.
- Sash lock provides a positive detent, reassuring user that the window is either locked or unlocked.
- Up to PG50 performance rating.
- Equal, Cottage, and Reverse Cottage sash provide a variety of looks and checkrail heights.
- Available in standard and special sizes up to 4 feet 6 inches wide by 7 feet high.
- Coordinating Picture and Transom windows also available.
- Double Hung Insert option features $\frac{3}{4}$ inch insert replacement frame with through jamb installation and up to PG40 performance rating.



DOUBLE HUNG



DOUBLE HUNG INSERT



Available with IZ3
(Excludes Insert option)

GLIDER



Glider window with white painted finish



Glider window with custom stain finish

GLIDER

- Operating sash easily tilts and removes with no cords or strings to detach.
- Tilt latches are ergonomically designed and easy to operate making tilting and cleaning effortless.
- Available in dual sash with left or right operating panel as well as triple sash with fixed center panel and two operating end panels.
- Innovative screen design for easy installation and removal.
- Up to PG30 performance rating.
- Available in standard and special sizes up to 6 feet wide by 5 feet high for dual sash and 8 feet wide by 5 feet high for triple sash.



INTERIOR



EXTERIOR



GLIDER PULL SHOWN IN STONE WHITE

PICTURE



Picture windows in Bronze



Picture windows with Designer Black finish

PICTURE

- Fixed window available in either in-sash or direct glaze to meet various design needs.
- Both in-sash and direct glaze Picture windows available with IZ3 hurricane rating.
- Direct glaze:
 - › Glass meets the frame directly without a sash for a simple, clean profile with more glass area.
- In-sash:
 - › Designed to match profiles of operable windows in the Elevate collection.
 - › Casement Picture windows available in sizes up to 6 feet wide by 6 feet high.
 - › Double Hung Picture windows available in sizes up to 5 feet wide by 7 feet high.

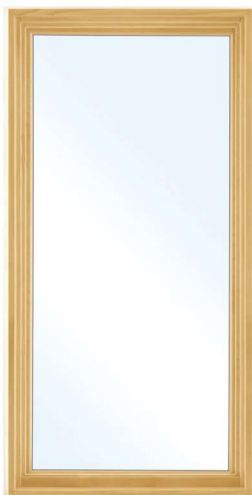

INTERIOR



EXTERIOR



PICTURE WINDOW PROFILE SHOWN IN BARE PINE



Available with IZ3

BAY + BOW



Double Hung Bay window



BAY + BOW

- Maximize air circulation with multiple windows.
- Combine Double Hung or Casement windows with a center Picture window.
- Customize with a variety of glass, divided lites, and hardware options.
- Rich Pine interior with a variety of finish options.
- Durable low-maintenance aluminum surround screens.
- Head and seat boards use engineered wood for superior strength, stability, and durability.
- Choose from convenient factory mulling or field mulling kits.
- Bows available in configurations up to 10 feet wide by 6 feet high.
- Bays available in configurations up to 7 feet wide by 6 feet high.



BAY INTERIOR



BAY EXTERIOR

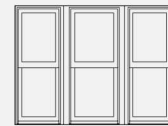

**BAY OPERATOR
CENTER UNIT**



**BAY PICTURE
CENTER UNIT**

ROUND TOP



Round Top and Casement windows with Stone White hardware



Round Top and Casement windows in Pebble Gray

ROUND TOP

- Glass reinforced composite material complements Ultrex's performance in a radius profile.
- Acrylic capping technology delivers consistent finish and durability.
- Available nailing fin, installation bracket, and through jamb installation.
- Perforated folding radius nailing fin provides for simple installation and proper water management.
- Available factory and field mulling options.
- Standard and special sizes up to 8 feet wide and up to 6 feet high depending on the shape.
- Up to PG50 performance rating.



EXTERIOR + INTERIOR

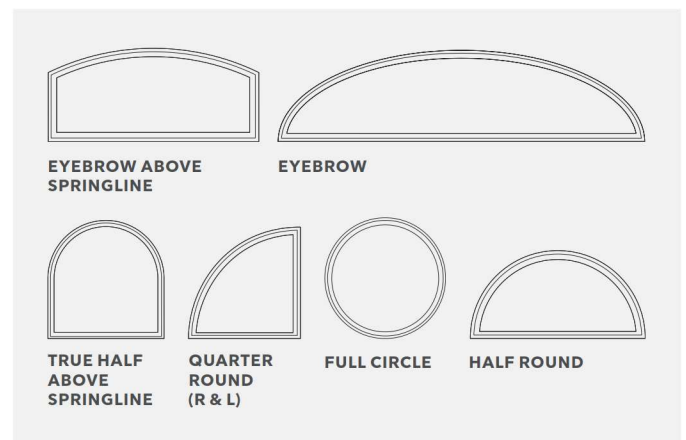

ALUMINUM ROUND TOP



Aluminum Round Top and Picture windows

ALUMINUM ROUND TOP

- Available in a wide variety of sizes, shapes, and options.
- Extruded aluminum cladding protects against extreme weather conditions.
- Grilles-Between-the-Glass available in six Elevate collection exterior colors.
- Finish meets or exceeds AAMA 2605 specifications.

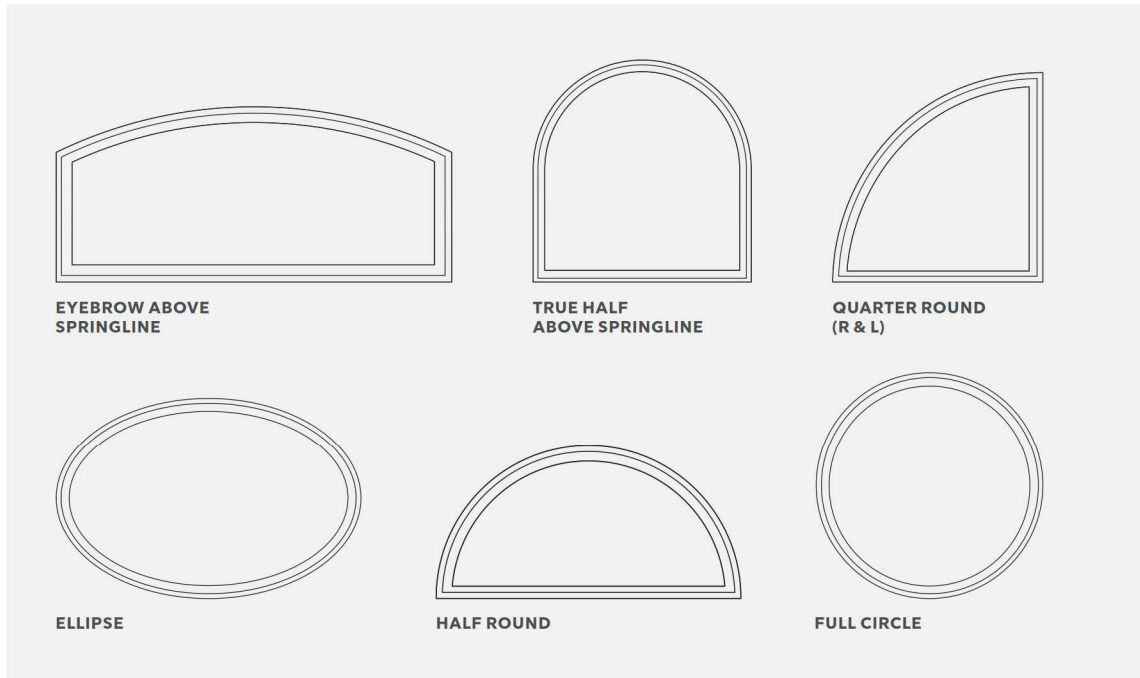

NUMEROUS SHAPES TO ACHIEVE
A CUSTOM LOOK AND EXPAND
DESIGN POSSIBILITIES.

SPECIALTY SHAPES



Specialty Shape windows

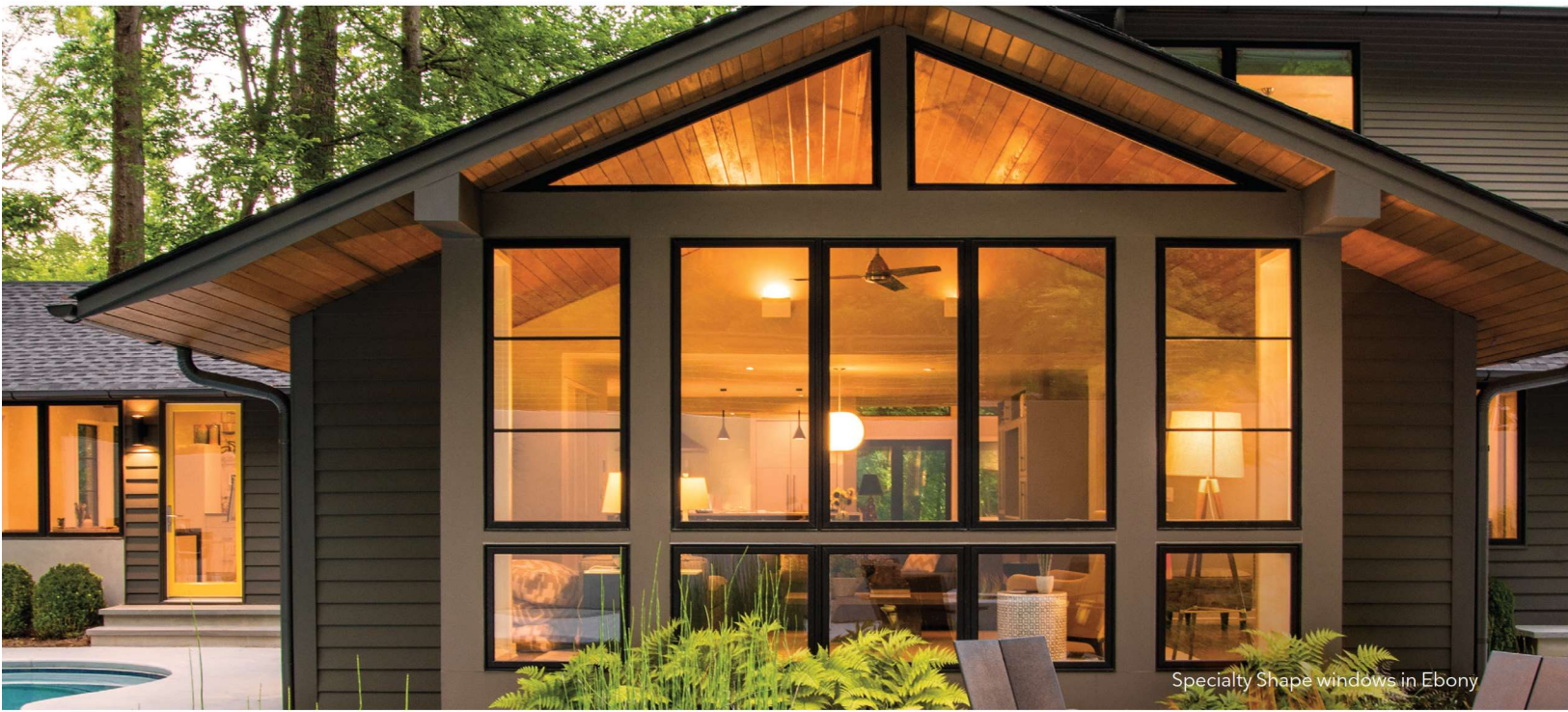

Specialty Shape windows in Ebony

SPECIALTY SHAPES

- Standard jambs of 4 1/16 inch, 6 1/16 inch, and 6 13/16 inch are available factory applied or as an extension kit.
- Consistent, fast delivery applies to even the most unique products.
- ENERGY STAR® certified and available with Low E1, Low E2, Low E3, and Low E3/ERS insulated glass.
- Up to PG55 performance rating.
- Factory, reinforced, and field mulling kits available.
- Use as sidelights or transoms, or combine for a breathtaking wall of windows.
- Available in sizes up to 49 square feet. Longest leg may not exceed 9 feet.



EXTERIOR PENTAGON



INTERIOR TRAPEZOID

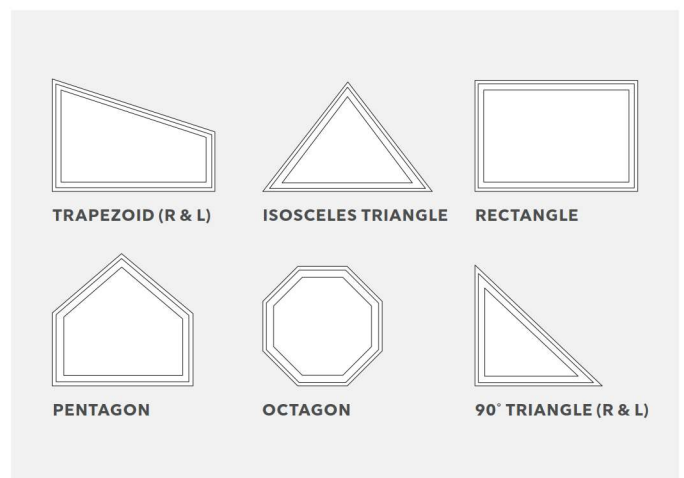

SLIDING PATIO DOOR



Sliding Patio door and Picture window



SLIDING PATIO DOOR

- Narrow stiles and rails achieve a contemporary styling.
- Low-maintenance Ultrex fiberglass exterior; rich pine interior with a variety of finish options.
- Precision built in special sizes in 1/4 inch increments.
- 2, 3 and 4-panel configurations, up to approximately 16 feet wide by 8 feet high.
- Up to PG40 performance rating.
- Top hung screen operates smoothly without jamming.
- Coordinating Transom windows available.
- Bronze or Beige sill available.



INTERIOR



EXTERIOR



NORTHFIELD HANDLES SHOWN IN OIL RUBBED BRONZE

SLIDING FRENCH DOOR



Sliding French door with Cambridge hardware in Oil Rubbed Bronze



Bi-parting Sliding French door in Bronze with Northfield hardware in Oil Rubbed Bronze

SLIDING FRENCH DOOR

- Wide stile and rail construction showcases the rich wood interior.
- Low-maintenance fiberglass exteriors and rich pine interiors with a variety of finish options.
- Configurations of 2, 3, or 4-panels, up to 16 feet wide by 8 feet high.
- Up to PG40 performance rating.
- Optional PG50 performance rating on 2 and 3-panel configurations up to 9 feet wide by 8 feet high.
- Dual ball-bearing rollers for smooth operation.
- Bronze or Beige sill available.



INTERIOR



EXTERIOR



SILL DETAIL SHOWN IN BRONZE



Available with IZ3

INSWING FRENCH DOOR



Inswing French door with Cambridge hardware in Satin Nickel

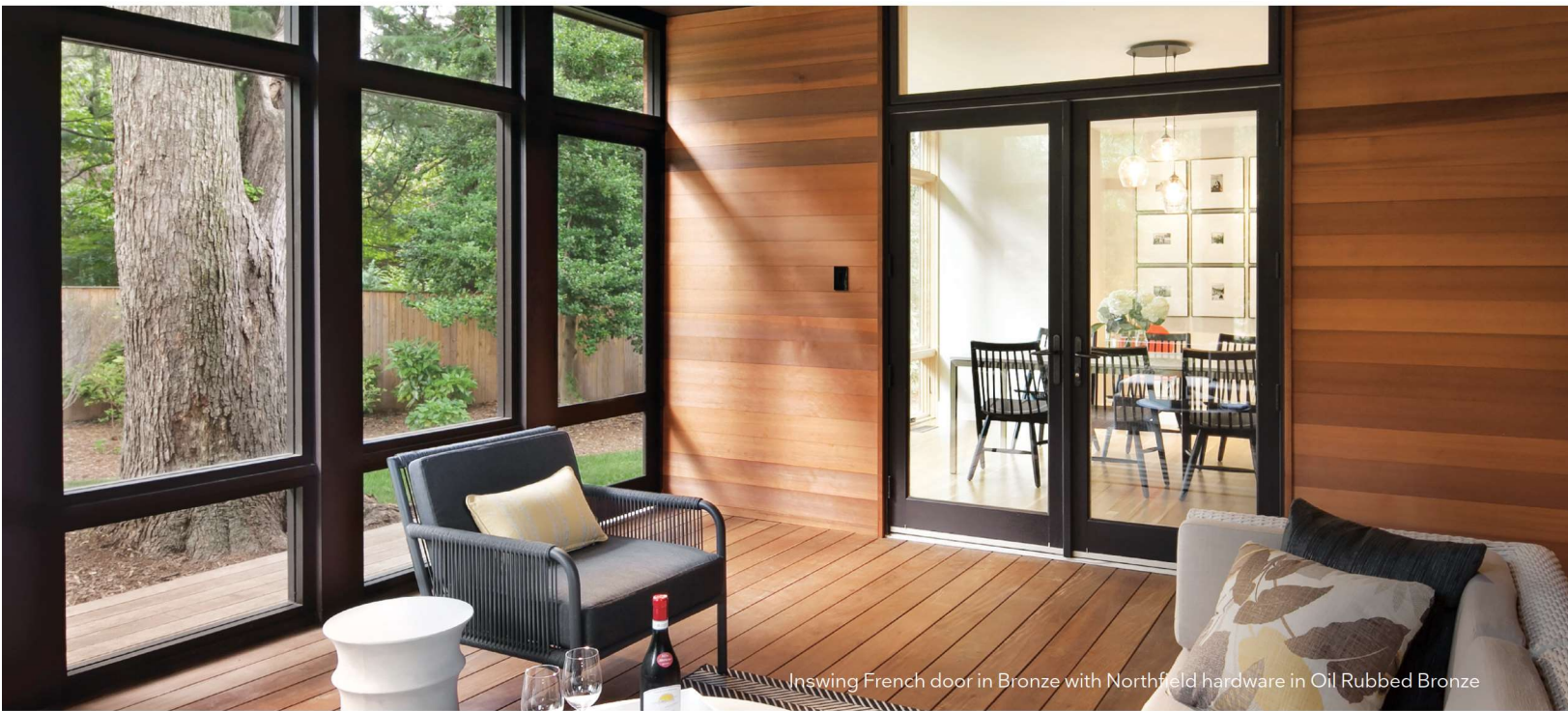

Inswing French door in Bronze with Northfield hardware in Oil Rubbed Bronze

INSWING FRENCH DOOR

- Secure and stable stainless steel multi-point locking system.
- Precision built in 1/4 inch increments.
- Available in 1, 2, or 3-panel configurations.*
- Multiple configurations up to 6 feet wide by 8 feet high.
- Bronze or Beige sill available.
- PG30 performance rating standard.
- PG50 performance rating optional on 1 and 2-panel configurations.



INTERIOR



EXTERIOR



SILL DETAIL SHOWN IN BRONZE



Available with IZ3

* 3 panel configuration is achieved by mulling multiple frames together to create an assembly.

OUTSWING FRENCH DOOR



Outswing French door with Northfield hardware in Matte Black



Outswing French door with Cambridge hardware in Satin Nickel

OUTSWING FRENCH DOOR

- Low-maintenance fiberglass exteriors and rich pine interiors with a variety of finish options.
- Secure and stable stainless steel multi-point locking system.
- Precision built in 1/4 inch increments.
- Tempered, insulated glass with argon gas.
- Available in 1, 2, or 3-panel configurations.*
- Multiple configurations up to 6 feet wide by 8 feet high.
- Bronze or Beige sill available.
- PG50 performance rating standard.



INTERIOR

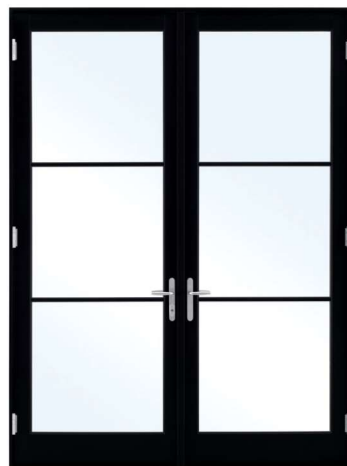

EXTERIOR



DOOR HINGE SHOWN IN SATIN NICKEL



Available with IZS

* 3 panel configuration is achieved by mulling multiple frames together to create an assembly.



Marvin Elevate™ collection

PRODUCT OPTIONS



Double Hung and Round Top windows in Stone White

INSTALLATION MADE SIMPLE AND EFFICIENT

INSTALLATION OPTIONS AND ACCESSORIES

1. NAILING FIN

Pre-attached folding nailing fin and drip cap for easier installation.



2. THROUGH JAMB

Available through-jamb and installation bracket options.

3. FACTORY-APPLIED JAMB EXTENSIONS

Factory-applied jamb extensions save time and labor. We supply 4 1/8", 6 1/8", and 6 13/16" jamb depth in bare wood, white, designer black, or clear interior finish.



4. FACTORY-INSTALLED SCREENS

Factory-installed screens are a standard offering with operating windows. At no extra cost, we can ship your screens separately to reduce on-site damage prior to installation.

5. FACTORY MULLED ASSEMBLIES

Available standard factory mulling, reinforced factory mulling, or field mulling kits. The reinforced mull meets AAMA 450 specifications and performs up to PG50 on standard products and up to PG55 on IZ3 rated products.



6. CORNER KEYS

Integral corner keys keeps window and door units square and corners sealed.

7. SPECIAL SIZES

Special sizes are available on windows and doors in 1/64" increments for the perfect fit every time.



8. PAINTABLE ULTREX EXTERIOR

The Ultrex® fiberglass exterior is paintable, and holds dark colors better than vinyl or vinyl/wood composites.

EXTERIOR TRIM

Ultrex Exterior Trim is offered with all rectangular Elevate products in all six exterior finishes. The durability, performance, and look of Marvin Elevate windows and doors can be extended to the trim.

BRICK MOULD

2" Brick Mould is available with or without 2 1/8" sill nosing.

FLAT

3 1/2" Flat Trim is available in Flat and Flat Ranch configurations with or without 2 1/8" sill nosing.

SILL NOSE

2 1/8" Sill Nose provides authentic sill appearance.

CONNECTION BARB

Barb and receiver attachment method provides for quick, secure installation.



Casement window with Flat Exterior Trim in Stone White



BRICK MOULD



FLAT



SILL NOSE



CONNECTION BARB

TRIM CONFIGURATIONS

Multiple configurations are available in lineal lengths and factory pre-cut kits in all six Elevate collection exterior colors.

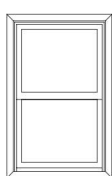

BRICK MOULD

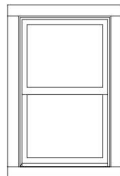

FLAT

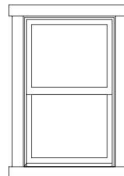

FLAT RANCH

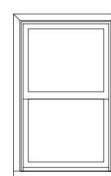

BRICK MOULD WITH SILL NOSE

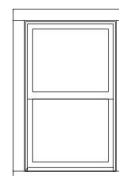

FLAT WITH SILL NOSE

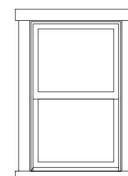

FLAT RANCH WITH SILL NOSE

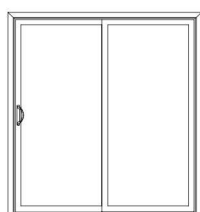

BRICK MOULD*



FLAT*



FLAT RANCH*

* Brick Mould, Flat, and Flat Ranch profiles are available on doors. Sill profiles are not included for door trim sets.

DESIGN OPTIONS

INTERIOR AND EXTERIOR FINISHES

Elevate windows and doors feature rich pine interiors and a durable, strong Ultrex® fiberglass exterior, featuring our AAMA-verified acrylic finish for low-maintenance and superior aesthetics.

WOOD INTERIOR FINISHES



FIBERGLASS EXTERIOR COLORS

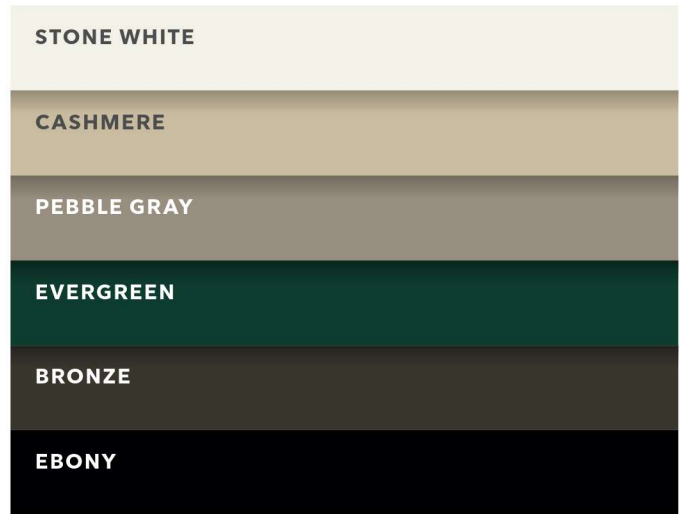

GRILLES

GRILLES-BETWEEN-THE-GLASS (GBG)

Available in several popular lite cut options for a classic divided lite look and easy glass cleaning. Available in Stone White, Bronze, and Ebony interior and Stone White, Cashmere, Pebble Gray, Evergreen, Bronze, or Ebony exterior.*

SIMULATED DIVIDED LITE (SDL)

Bars permanently adhered to both sides of the glass for a more authentic look. Available with or without spacer bar and in several lite cut options.



GRILLES-BETWEEN-THE-GLASS



SIMULATED DIVIDED LITE

GLASS OPTIONS

Glass is available with Standard Dual Pane or optional Triple Pane on select products. Available with Low E1, Low E2, Low E3, and Low E3/ERS insulated glass with argon gas.* Options include glazing for sound abatement (STC/OITC), high altitudes, and California fire zones. Laminated glass is also offered in products designed specifically for hurricane zones.

DECORATIVE GLASS

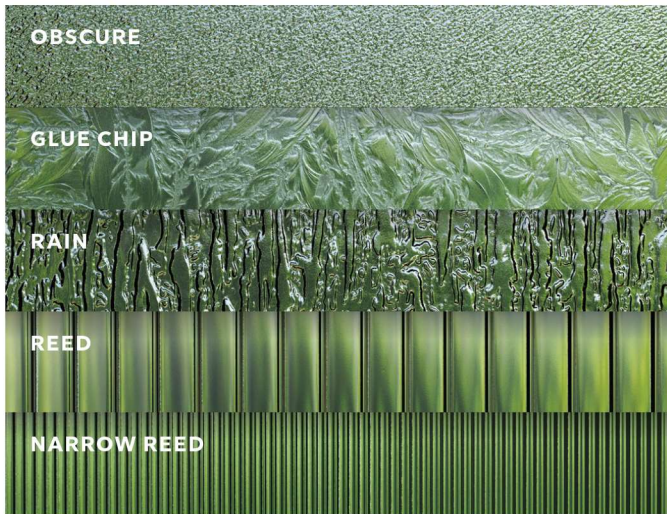

SIMULATED CHECKRAIL

Simulated Checkrail is the perfect solution when aesthetics call for the beauty of a double hung, but operation, egress, or performance demand another solution.

You specify placement of the horizontal simulated checkrail bar and the lite cut patterns above and below.

These illustrations offer a sampling of 7/8" Simulated Divided Lite (SDL) patterns that can be selected in combination with the 2 11/32 inch Simulated Checkrail on Casement, Awning, Glider, Direct Glaze Rectangle, Picture windows, and all Elevate doors.

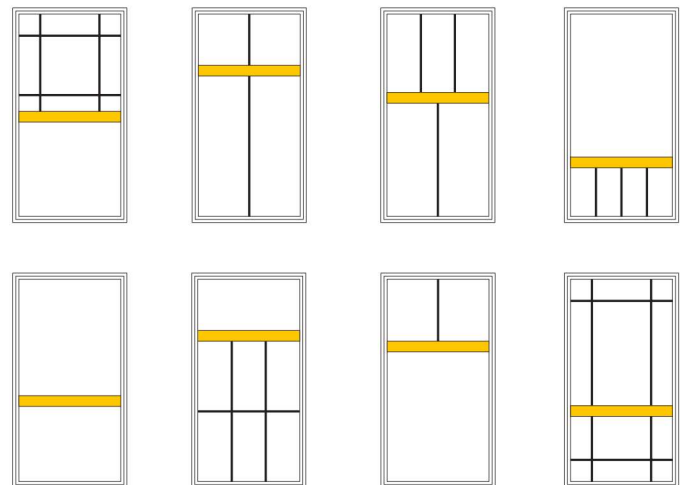

* Argon gas not available in high elevations where capillary tubes are required.

HARDWARE STYLES

WINDOW HARDWARE

Windows feature classic low-profile durable hardware for clean aesthetics, safety, and security.



SASH LOCK

Double Hung, Single Hung, and Glider



FOLDING HANDLE

Casement and Awning



Casement windows with Satin Nickel Folding Handle

DOOR HANDLES

Door handles are available in two distinct hardware styles.



CAMBRIDGE



NORTHFIELD

DOOR HANDLE OPTIONS

- Available keyed-alike option (use one key on multiple locks, with up to 3 different keys on each project).
- Choose a distinct interior and exterior handle finish that matches or complements the interior and exterior color of your door.

FINISHES



Choose from a variety of hardware finishes to complement your Elevate collection windows and doors.

The Physical Vapor Deposition (PVD) process adds a layer of toughness to hardware exposed to environmental factors like direct sun and humidity. PVD finishes resist fading and discoloration, even in coastal areas. PVD has the highest grade corrosion resistant finish.

PVD finish is available on exterior door hardware in Oil Rubbed Bronze, Satin Nickel, and Brass.



SAFE AND SOUND

ACCESSIBILITY OPTIONS

OPENING CONTROL DEVICE

Limits opening to 4 inches, while providing for full egress. ASTM F2090 compliant. Available on Casement, Double Hung, Single Hung, and Glider windows.

SASH LIMITER

Permanently limits sash movement for safety and security.



**CASEMENT
OPENING CONTROL DEVICE**



**DOUBLE HUNG
OPENING CONTROL DEVICE**



**GLIDER
OPENING CONTROL DEVICE**



**AWNING
SASH LIMITER**

IZ3 PRODUCTS FOR COASTAL LIVING

Our Elevate IZ3 Certified products are specifically designed for the extreme conditions and construction requirements of coastal areas. Rigorously tested by third-party agencies to meet or exceed the most stringent coastal codes, they protect against flying debris, driving rain, cyclic pressure, and extreme temperatures. The Ultrex® fiberglass finish passes AAMA 624 standards for weathering and fading resistance.





I23 Outswing French door and I23 Casement windows

IN HARSH COASTAL CONDITIONS, YOUR WINDOWS AND DOORS MATTER

Marvin offers windows and doors specifically designed for the coast.

THE MARVIN ELEVATE
COLLECTION IS AN IDEAL BLEND
OF REMARKABLE DESIGN AND
SUPERIOR STRENGTH.

Patented fiberglass exteriors stand up to all elements, outperforming and outlasting vinyl, roll-form aluminum, and other fiberglass composites. Warm wood interiors add timeless beauty, while resilient, long-lasting fiberglass stays strong in even the toughest conditions.



Double Hung and Casement windows in Stone White



Since we opened as a family-owned and -operated lumber and cedar company in 1912, Marvin has designed products to help people live better. We remain committed to bringing beauty and simplicity into people's lives with windows and doors that stand the test of time.

MARVIN.COM

©2019 Marvin Lumber and Cedar Co., LLC. All rights reserved.
®Registered trademark of Marvin Lumber and Cedar Co., LLC.
ENERGY STAR® and the ENERGY STAR certification mark are registered US marks.

Part #19981914. December 2019.

Colors shown in printed materials are simulations and may not precisely duplicate product or finish colors. Contact your local Marvin dealer to view actual product and finish color samples.